

OLYMPUS

DIGITAL VOICE RECORDER

DM-720

USER MANUAL

Getting started

1

Recording

2

Playback

3

Menu

4

Use with a PC

5

Other information

6

Thank you for purchasing an Olympus digital voice recorder.
Please read these instructions for information about using the product
correctly and safely.

Keep the instructions handy for future reference.

To ensure successful recording, we recommend that you test the record
function and volume before use.



Table of contents

Names of parts	4
Recorder	4
Display	5

1 Getting started

Setup	8
Inserting the battery	9
Turning the power ON	10
Selecting the battery setting	10
Setting the time/date	11
Setting the voice guidance	11
Charging the battery	12
Charging the battery by connecting to a PC's USB connector	12
Charging the battery by connecting to an AC adapter with a USB connection (model A514; optional)	13
Batteries	15
Inserting/removing a microSD card	17
Inserting a microSD card	17
Removing a microSD card	18
Preventing accidental operation	19
Setting HOLD mode	19
Releasing HOLD mode	19
Turning the power OFF	20
[Home] screen operations	21
Selecting the mode	21
Selecting folders and files	22
Attaching the stand clip (CL4)	24

2 Recording

Recording	25
Basic recording procedure	25
Pausing/resuming recording	27
Quickly checking a recording	27
Monitoring while recording	28
Selecting the automatic recording setting [Rec Scene]	29
Changing the recording scene	29
Recording with an external microphone	32
Recording from another connected device	33
Recording audio from another device with this recorder	33
Recording audio from this recorder with another device	33

3 Playback

Playback	34
Basic playback procedure	34
Fast-forwarding	35
Rewinding	35
Skipping to the beginning of a file	36
Playback through the earphones	37
Selecting the automatic playback operation [Play Scene]	39
Changing the playback speed	41
ABC repeat playback	42
Index marks/temp marks	45
Writing an index mark/temp mark	45
Erasing an index mark/temp mark	45
Calendar Search function	46
Erasing files/folders	47
Erasing files	47
Erasing a folder	48

4 Menu

Setting menu items	49
Basic operation	49
File menu [File Menu]	52
Extracting the speaking portions of files of spoken-word content [Voice Detect]	52
Preventing accidental file erasure [File Lock]	52
Sorting files [Sort by]	52
Moving/copying files [Move/Copy]	53
Dividing files [File Divide]	53
Partially erasing files [Partial Erase]	53
Displaying file or folder information [Property]	53
Recording menu [Rec Menu]	54
Selecting the recording level [Rec Level]	54
Setting the recording mode [Rec Mode]	55
Selecting microphone directivity [Zoom Mic]	55
Reducing noise during recording [Low Cut Filter]	56
Selecting the three microphones system [Mic Select]	56
Voice-activated recording function [VCVA]	57
Voice sync recording function [V-Sync. Rec.]	58
Setting timer recording [Timer Rec.]	59

Table of contents

Playback menu [Play Menu]	60
Skipping non-voice portions during playback [Voice Playback].....	60
Alternating repeatedly between normal and muted playback [Shadowing]	60
Reducing noise during playback [Noise Cancel].....	61
Adjusting low volume portions during playback [Voice Balancer]	61
Selecting playback modes [Play Mode]	62
Changing music sound quality [Equalizer].....	63
Setting a skip space [Skip Space]	63
LCD/Sound menu [LCD/Sound Menu]	65
Setting the backlight [Backlight]	65
Adjusting the contrast [Contrast].....	65
Setting the LED indicator light [LED].....	65
Turning beeping sound on/off [Beep].....	65
Changing the display language [Language]	65
Setting the voice guidance [Voice Guide].....	66
Playing the beginning of files automatically [Intro Play].....	66
Selecting the speaker output [Speaker].....	66
Device menu [Device Menu]	67
Selecting the recording media [Memory Select].....	67
Setting power save mode [Power Save].....	67
Setting the battery in use [Battery]	67
Setting the time/date [Time & Date]	68
Setting the USB connection [USB Settings]	69
Restoring the default settings [Reset Settings].....	69
Formatting a recording media [Format].....	70
Checking recording media information [Memory Info.].....	70
Checking voice recorder information [System Info.]	70
Extracting the speaking portions of files of spoken-word content [Voice Detect]	71
Moving/copying files [Move/Copy]	73
Dividing files [File Divide]	76
Partially erasing files [Partial Erase]	78
Setting timer recording [Timer Rec]	80
Setting the voice guidance [Voice Guide]	84
Setting the USB connection [USB Settings]	86
Formatting recording media [Format]	88

5 Use with a PC

PC operating environment	90
PC connection/disconnection	92
Connecting the voice recorder to a PC.....	92
Disconnecting the voice recorder from a PC	94
Transferring files to a PC	95

6 Other information

Alarm message list	97
Troubleshooting	99
Recorder care	102
Accessories (optional)	103
Copyright and trademark information	104
Safety precautions	105
Specifications	110

Indications used in this manual

NOTE

Describes precautions and operations that should be absolutely avoided in using the voice recorder.

TIP

Describes useful information and hints that will help you getting the most out of your voice recorder.



Indicates reference pages describing details or related information.

Names of parts

Recorder

Names of parts

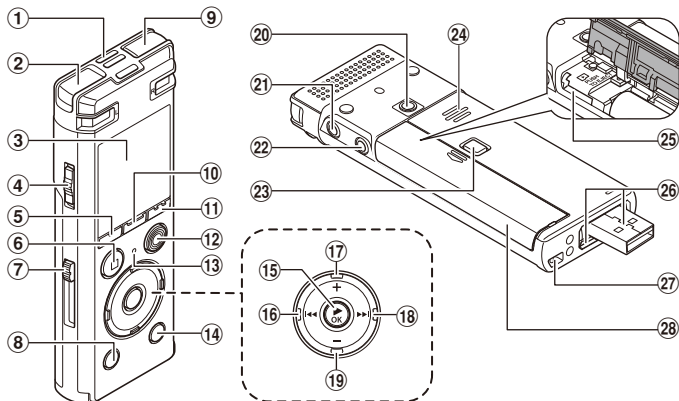

- ① Built-in center microphone
- ② Built-in stereo microphone (L)
- ③ Display
- ④ POWER/HOLD switch
- ⑤ F1 button
- ⑥ STOP (■) button
- ⑦ USB connector slide lever
- ⑧ ERASE button
- ⑨ Built-in stereo microphone (R)
- ⑩ MENU/SCENE button
- ⑪ F2 button
- ⑫ REC (record)(●) button
- ⑬ LED indicator light (LED)
- ⑭ LIST button
- ⑮ ►OK button
- ⑯ ◀◀ button
- ⑰ + button
- ⑱ ▶▶ button
- ⑲ – button
- ⑳ Attachment mounting hole
- ㉑ Earphone jack (🎧)
- ㉒ Microphone jack (🎤)
- ㉓ Battery/card cover lock button
- ㉔ Built-in speaker
- ㉕ microSD card slot
- ㉖ USB connector/USB connector cover (retractable)
- ㉗ Strap hole
- ㉘ Battery/card cover

Names of parts

Display

■ [Recorder] mode

Folder list display

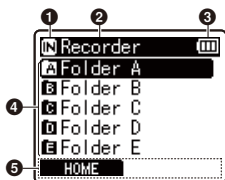

File list display

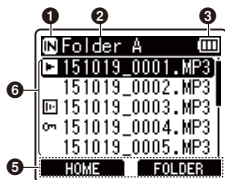

File display

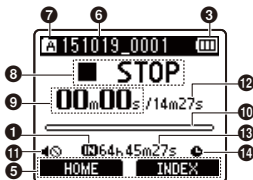

1 Recording media indicator

[N]: Internal memory

[M]: microSD card

2 Current folder name

3 Battery indicator

4 Folder name

5 Function button guide display

6 File name

[▶]: Playback indicator

[V]: Voice Detect

[L]: File lock indicator

7 Folder indicator

8 Voice recorder status indicator

[R]: Recording indicator

[R]: Recording pause indicator

[■]: Stop indicator

[▶]: Playback indicator

[▶]: Fast playback indicator

[▶]: Slow playback indicator

[▶▶]: Fast-forward indicator

[◀◀]: Fast-rewind indicator

9 Elapsed recording time (during recording mode), playback time (during playback mode)

10 Level meter (during recording mode), playback position indicator (during playback mode)

11 Speaker muting indicator (M)

12 File length

13 Possible recording time remaining

14 Timer recording indicator (T)

Names of parts

Display

■ [Music] mode

List display ①

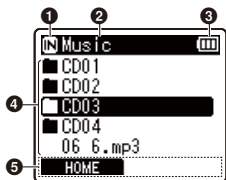

When folder contains files and folders

List display ②

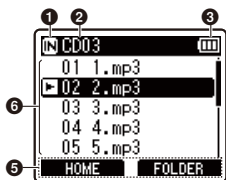

When folder contains only files

File display

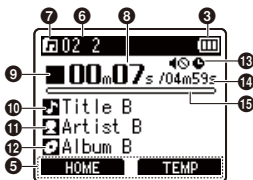

① Recording media indicator

- [IN]: Internal memory
- [MC]: microSD card

② Current folder name

③ Battery indicator

④ Folder name or file name

⑤ Function button guide display

⑥ File name

- [▶]: Playback indicator
- [🔒]: File lock indicator

⑦ Folder indicator

⑧ Elapsed playback time

⑨ Voice recorder status indicator

- [■]: Stop indicator
- [▶]: Playback indicator
- [▶▶]: Fast playback indicator
- [▶▶▶]: Slow playback indicator
- [▶▶▶▶]: Fast-forward indicator
- [◀◀]: Fast-rewind indicator

⑩ Music title

⑪ Artist name

⑫ Album name

⑬ Speaker muting indicator (🔇), timer recording indicator (🕒)

⑭ File length

⑮ Playback position bar indicator

Display

TIP

- Pressing and holding the **STOP** (■) button while the voice recorder is in stop mode displays the settings **[Time & Date]** and **[Remain]** (amount of possible recording time remaining). If the current time/date is set incorrectly, see “**Setting the time/date [Time & Date]**” (P.68).

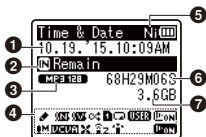

- 1 Current time & date**
- 2 Recording media indicator**
- 3 Recording format indicator**
- 4 Indicator display area**

[🎮]: Play Scene
[🎧 CONF.]: Rec Scene
[🔊]: Noise Cancel
[🗣️]: Voice Balancer
[🎲]: Random
[🔍]: Playback Range
[🔄]: Repeat

[🔊 USER]: Equalizer
[🔊 ON]: Voice Playback
[🔊 M]: Rec Level
[🔊 VCVA]: VCVA
[🔊 SYNC]: V-Sync. Rec
[🔊 LF]: Low Cut Filter
[🔊 Z]: Zoom Mic
[🔊 M]: Mic Select
[🔊 ON]: Voice Detect

- 5 Battery indicator**
[Ni]: Ni-MH
[A]: Alkaline
- 6 Possible recording time**
- 7 Available free space**

Getting started

Setup

1

After unpacking the voice recorder, follow the steps below to have it ready for use.

Setup

Getting started **1**

Inserting the battery

Getting started **2**

Turning the power ON

Getting started **3**

Selecting the battery setting

Select the battery setting to match the inserted battery. Select the setting for a nickel-metal hydride rechargeable battery or the setting for an alkaline battery.

Getting started **4**

Setting the time/date

Set the voice recorder's clock for use with file management.

Getting started **5**

Setting the voice guidance

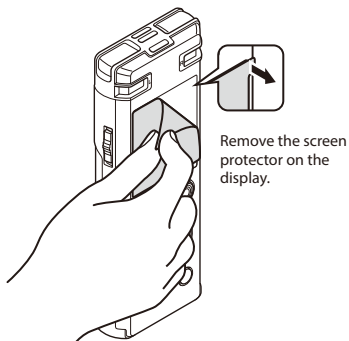

Remove the screen protector on the display.

Inserting the battery

Before using the voice recorder, insert the battery in the battery compartment of the voice recorder.

- 1 Press and hold the battery/card cover lock button, and then slide the battery/card cover to open.**

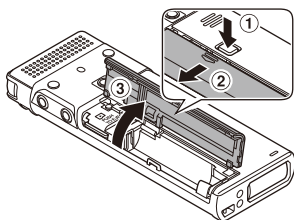

- 3 Slide the battery/card cover completely closed.**

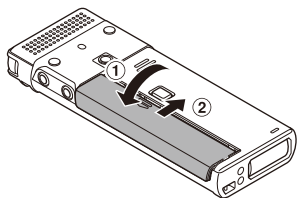

- 2 Insert a AAA battery, making sure its positive and negative terminals are placed correctly.**

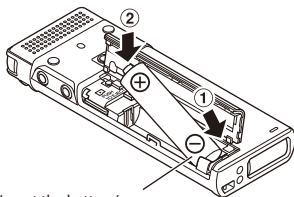

Insert the battery's negative terminal first

Turning the power ON

- 1 While the voice recorder is turned off, slide the **POWER/HOLD** switch in the direction of the arrow.

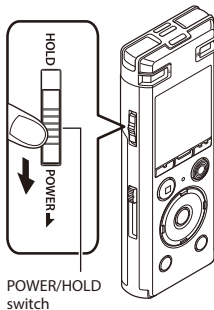

Selecting the battery setting

- 1 Press the **+** or **-** button to select the type of battery you inserted.

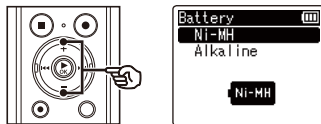

[Ni-MH]

Select if you inserted an Olympus nickel-metal hydride rechargeable battery (model BR404).

[Alkaline]

Select if you inserted an alkaline battery.

- 2 Press the **▶ OK** button to finalize the setting.

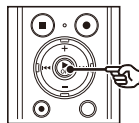

NOTE

- See “**Setting the time/date**” if a time display with a blinking cursor on the hour appears in the display after setting the battery (P.11).

Setting the time/date

- 1 Press the **▶▶▶** or **◀◀◀** button to select the item to set.

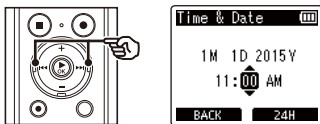

- 2 Press the **+** or **-** button to change the number.

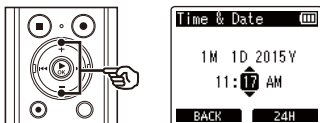

- To change the setting of another item, press the **▶▶▶** or **◀◀◀** button to move the blinking cursor, then press the **+** or **-** button to change the number.

- 3 Press the **▶OK** button to finalize the setting.

TIP

- You can press the **▶OK** button during the setting procedure to set the items entered so far and start the clock.
- You can change the clock display format. See "Setting the time/date [Time & Date]" (P.68) for the procedure.

Setting the voice guidance

Using this feature, a voice announces the operating conditions of the recorder.

- 1 Press the **+** or **-** button to select [On] or [Off].

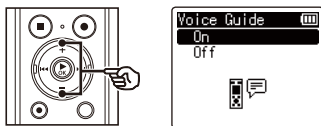

[On]

Voice guidance will be enabled.

[Off]

Voice guidance will be canceled.

- 2 Press the **▶OK** button to finalize the setting.

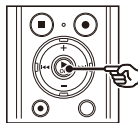

TIP

- [On/Off], [Speed], and [Volume] can be set for the voice guidance. See "Setting the voice guidance [Voice Guide]" (P.84) for the procedure.

Charging the battery

Charging the battery by connecting to a PC's USB connector

NOTE

- Before charging the battery, insert the rechargeable battery provided and set [Battery] to [Ni-MH] (P.9, P.10).

1 Start the PC.

2 Slide the USB connector slide lever in the direction of the arrow.

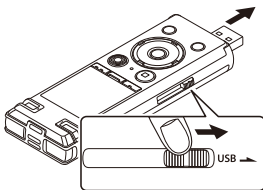

- The USB connector extends out. The USB connector cover is stored inside the voice recorder.

3 After making sure the voice recorder is stopped, connect the USB connector to a USB port on a PC.

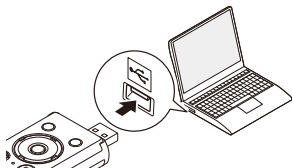

4 Press the ►OK button to start charging the battery.

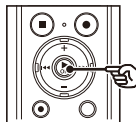

- When [Battery] (P.67) is set to [Ni-MH], [Press OK to start charging] appears on the display. Press the ►OK button while this message is blinking.

5 Charging has finished when the battery indicator changes to [Full].

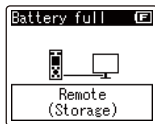

Charging time: About 3 hours*

- * Approximate time needed to fully charge a completely flat battery at room temperature. Battery charging time will depend on the amount of remaining power and the state of the battery.

Charging the battery

1

Charging the battery

Charging the battery by connecting to an AC adapter with a USB connection (model A514; optional)

NOTE

- Before connecting the AC adapter, select **[AC Adapter]** for the USB connection setting (☞ P.86).
- Before charging the battery, insert the rechargeable battery provided and set **[Battery]** to **[Ni-MH]** (☞ P.9, P.10).
- Use only the Olympus USB connecting AC adapter model provided (A514).

- 1 Connect the voice recorder to the USB connector on the AC adapter.**

To USB connector of AC adapter (model A514)

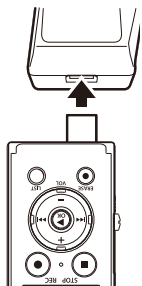

- 2 Connect the AC adapter to an AC power outlet.**



To an AC power outlet

- 3 Press the ►OK button to start charging.**

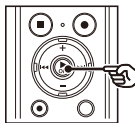

- When **[Battery]** (☞ P.67) is set to **[Ni-MH]**, **[Press OK to start charging]** appears on the display. Press the ►OK button while this message is blinking.

EN

13

Charging the battery

1

Charging the battery

4 Charging is finished when [Battery full] appears.

When charged with the power turned off

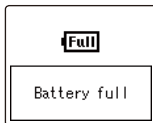

Displayed when the battery is fully charged

When charged with the power turned on

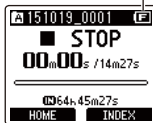

NOTE



- Never attempt to charge an alkaline battery, lithium battery or other primary cell battery. Fluid leakage or overheating may cause the recorder to malfunction.
- The power of the PC must be ON to charge the battery using the USB connector. You cannot charge the battery when the power of the PC is OFF, or the PC is in standby, sleep or auto power OFF mode.
- Do not use a USB hub when charging the battery by connecting to the PC.
- You cannot charge the battery if [C]¹ or [H]² is blinking. Charge the battery in an ambient temperature of between 5 and 35°C (41 and 95°F).
 - *1 [C] Ambient temperature is too low.
 - *2 [H] Ambient temperature is too high
- If battery life has become noticeably short on a full charge, replace the battery with a new one.
- Insert the USB connector securely all the way. Operation will not be normal if the connection is not made properly.
- Use only a compatible Olympus USB extension cable. Operation is not guaranteed if another manufacturer's cable is used. Only use the Olympus USB extension cable with the voice recorder and never use if a product from another manufacturer is used.
- To charge the battery with [USB Settings] set to [Composite], set [USB Connection] to [Optional] before charging. When you select [AC Adapter] for the [USB Connection] you can charge the battery (P.86).

Batteries

Battery indicator

As the battery loses its remaining charge, the battery indicator on the display changes as follows:



- [] indicates there is little remaining battery charge. Charge the battery or replace it with a fresh one. When the battery has run out, [] and **[Battery low]** appear, and operation stops.

Rechargeable batteries

Read the information below carefully when using a nickel-metal hydride rechargeable battery (model BR404).

■ Discharging

Rechargeable batteries discharge naturally when not in use. Be sure to charge the battery before use.

■ Operating temperature

Rechargeable batteries are chemical-based products. Their performance can vary even when used within the recommended operating temperature range. This variation is normal.

■ Recommended temperature ranges

When powering voice recorder: 0 to 42°C (32 to 107.6°F)

When being charged: 5 to 35°C (41 to 95°F)

During long-term storage: -20 to 30°C (-4 to 86°F)

Use of a rechargeable battery outside the temperature ranges above may result in drops in battery performance or life. When not using the voice recorder for an extended period, remove the rechargeable battery before storage to prevent fluid leakage or rust.

NOTE

- Due to the nature of nickel-metal hydride rechargeable batteries, new batteries and batteries not used for an extended period (one month or more) may not charge completely. The battery should become fully charged after charging and discharging the battery up to three times.
- Always dispose rechargeable batteries in the legally prescribed manner. Before disposing rechargeable batteries that are not fully discharged, take steps to prevent shorting such as insulating their terminals with tape.
- When buying rechargeable batteries, always select model BR404 nickel-metal hydride rechargeable batteries. Operation is not guaranteed if a battery from another manufacturer is used.
- The continuous battery usage time of a nickel-metal hydride rechargeable battery that has been used repeatedly will be reduced due to battery degradation (☞ P.112).

Battery precautions

- The voice recorder does not support manganese batteries.
- Always turn power OFF before replacing the battery. Files may be damaged if the battery is removed while the voice recorder is recording or performing an operation such as erasing a file.
- If the batteries are removed from the voice recorder, the [Time & Date] screen is displayed automatically when the power is turned on. See “Setting the time/date [Time & Date]” (☞ P.68) for the procedure.
- When not using the voice recorder for an extended period, always remove the battery before storage.
- When replacing the battery, use an AAA alkaline dry cell battery or an Olympus nickel-metal hydride rechargeable battery (model BR404).
- Even if the battery indicator is [☐], playback with the built-in speaker at some volumes may result in a drop in battery output voltage, causing the voice recorder to reset. Lower the volume in this case.
- The continuous battery usage time is reduced when using a microSD card (☞ P.112).
- The continuous battery usage time will vary depending on the performance of the battery in use (☞ P.112).
- The [Battery] screen appears automatically after you have replaced the battery. You can also use a menu operation to display this screen and set the battery (☞ P.67).

Inserting/removing a microSD card

The voice recorder has its own internal memory, and also supports standard microSD cards (microSD, microSDHC) sold separately.

Inserting a microSD card

- 1 While the voice recorder is in stop mode, open the battery/card cover.**

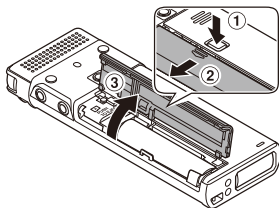

- The microSD card slot is inside the battery/card cover.

- 2 Insert a microSD card, making sure it is placed correctly as shown.**

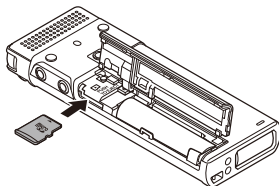

- Insert the microSD card straight, avoiding crooked insertion.
- Inserting a microSD card the wrong way or crookedly could damage its contact surface or cause it to jam in the slot.
- A microSD card not inserted fully (until it clicks into place) might not record data.

- 3 Close the battery/card cover.**

- The recording media selection screen appears after a microSD card has been inserted.

- 4 To record onto the microSD card, press the + or – button and select [Yes].**

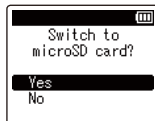
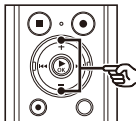

- 5 Press the ►OK button to finalize the setting.**

TIP

- You can also select the internal memory as the recording media (☞ P.67).

NOTE

- The voice recorder may not be able to recognize a microSD card formatted (initialized) for a PC or other device. Before using a microSD card, always initialize it on the voice recorder (☞ P.88).

Inserting/removing a microSD card

1

Removing a microSD card

- 1 While the voice recorder is in stop mode, open the battery/card cover.

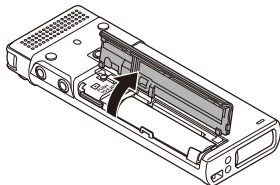

- 2 Release the microSD card by pressing it inward, then letting it slowly return.

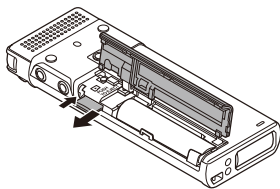

- The microSD card moves outward and stops. Pull the microSD card out with your fingertips.
- **[Internal memory selected]** is displayed after removing a microSD card if **[Memory Select]** was set to **[microSD card]**.

- 3 Close the battery/card cover.

NOTE

- microSD cards may pop out forcefully on removal if you flick or release your finger too quickly after pressing the card in.
- Depending on the card's manufacturer and type, some microSD cards and microSDHC cards may not be fully compatible with the voice recorder and not be recognized properly.
- For microSD card compatibility under Olympus verification, please contact our customer support at:

<http://www.olympusamerica.com>

Note that our customer support will provide information on microSD card manufacturers and card types for which Olympus has verified operation, but will not guarantee its performance.

Also note that some cards may no longer be recognized correctly by the voice recorder in case card manufacturer changes card specifications.

- Read the operating instructions provided with the card when using a microSD card.
- If a microSD card is not recognized by the voice recorder, try removing and reinserting the card to have the voice recorder attempt recognition again.
- Processing speed may be low for some microSD card types. Processing performance may also be reduced by writing or deleting data repeatedly from a microSD card. In this case, reinitialize the card (P.88).

Preventing accidental operation

Setting the voice recorder to HOLD mode maintains the current operation and disables button operations. HOLD mode is a handy feature for preventing unintentional operation from accidental button presses when the voice recorder is carried in a bag or pocket. It is also useful for preventing the voice recorder being accidentally stopped during recording.

Setting HOLD mode

- 1 Slide the **POWER/HOLD** switch to the **[HOLD]** position.

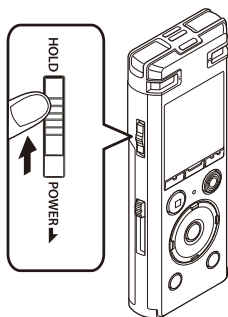

Releasing HOLD mode

- 1 Slide the **POWER/HOLD** switch to position **A** shown below.

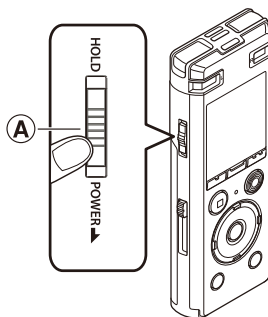

- **[Hold]** appears in the display, and the recorder enters HOLD mode.

NOTE

- When any button is pressed during HOLD mode, **[Hold]** appears in the display for 2 seconds. No other operation is performed.
- Setting HOLD mode during voice recorder playback (or recording) continues the playback (or recording) operation and prevents any other operation from being performed. (The voice recorder stops when playback ends or when recording ends because, for example, there is no remaining memory space.)

Turning the power OFF

Existing data, mode settings and the clock setting are saved when the power is turned off.

1

- 1 Slide the **POWER/HOLD** switch in the direction of the arrow for at least half a second.

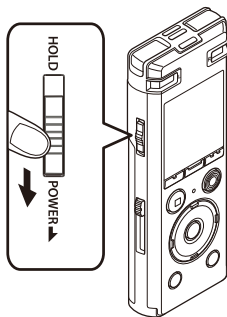

- The playback stop position at power OFF is stored in memory.

TIP

- Turning the power OFF whenever the voice recorder is not in use minimizes battery consumption.

Power Save mode

When the voice recorder has been stopped for at least 10 minutes (default setting) after power ON, the display disappears and the voice recorder automatically enters the Power Save mode (P.67).

- Pressing any button releases the Power Save mode.

[Home] screen operations

Selecting the mode

In addition to its recording function, the voice recorder also provides music player functions. Choose the application you want by selecting one of the voice recorder's modes.

- 1 While the voice recorder is in stop mode, press the F1 (HOME) button to display the [Home] screen.

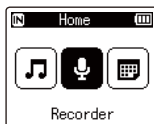

- 2 Press the >>> or <<< button to select the desired mode.

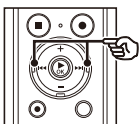

- 3 Press the > OK button.

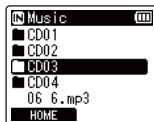
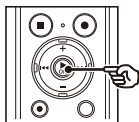

When [Recorder] is selected:

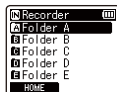

The voice recorder enters [Recorder] mode. Audio can be recorded with the built-in microphone. Files recorded with the built-in microphone can also be played back (P.25, P.34).

When [Music] is selected:



The voice recorder enters [Music] mode. In this mode you can play music files transferred to the voice recorder (P.34).

When [Calendar Search] is selected:



The voice recorder enters [Calendar Search] mode. In this mode you can search for files by specifying the recording date (P.46).

Selecting folders and files

You can select a different folder while the voice recorder is in stopped or playing a file. See “**Transferring files to a PC**” (P.95) for a description of the voice recorder’s hierarchical folder structure.

1

Selecting folders and files

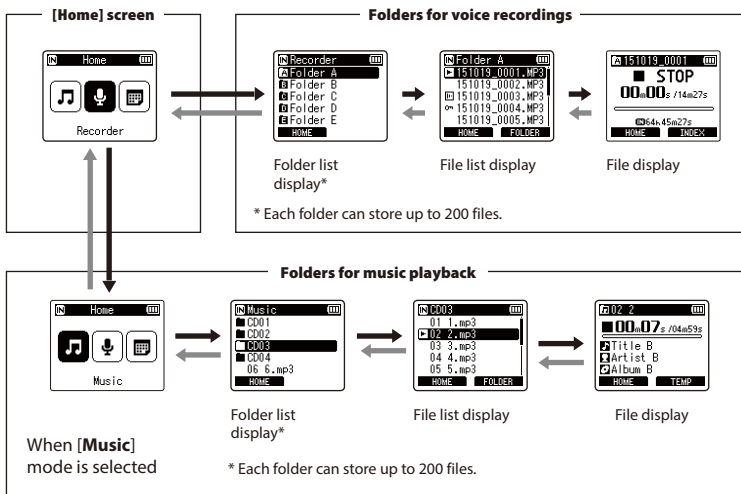

→ Forward: ► OK button

Each press on the ►OK button opens the currently selected folder or file in the list, moving forward to the next (lower) level in the folder hierarchy. When a list is displayed, you can perform the same function by pressing the ►►I button.

← Back: LIST button

Each press on the LIST button moves back to the previous (higher) level in the folder hierarchy. When a list is displayed, you can perform the same function by pressing the I◀◀ button.

TIP

- When navigating through a folder hierarchy, you can press and hold the LIST button to return to the file display.

+ or – button

Used to select a folder or file.

Selecting folders and files

[Home] screen

Used to select the voice recorder mode
( P.21).

List display

Displays the folders and files recorded in
the voice recorder.

Pressing the **F2 (FOLDER)** button changes
the display to the list display of the next
folder.

File display

Displays the information of the selected file.

Attaching the stand clip (CL4)

The voice recorder can be attached with a clip to the inside of a pocket of your clothes to prevent it from dropping when you take it out with you. You can also use the clip as a stand when you place the voice recorder on a table for recording.

1

Attaching the stand clip (CL4)

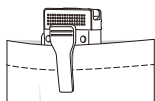

- 1 Align the protrusion on the back of the clip with the locating hole at the back of the voice recorder.**

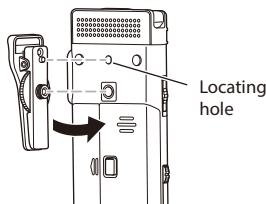

- 2 Turn the screw of the clip with your fingers to fix the clip to the voice recorder.**

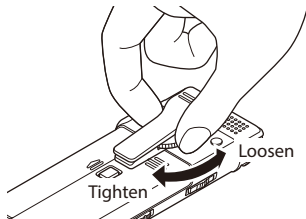

NOTE

- Do not strongly tighten when attaching the clip to the voice recorder. Damage may result.
- Do not attach other than a dedicated attachment. The voice recorder may be damaged.
- The clip is for thin material such as the pocket of clothing. Be sure to do the following when using the clip because incorrect use may result in the clip being damaged or the voice recorder being damaged as a result of it dropping.
 - When using the clip, insert the voice recorder inside a pocket or alike and secure it with the clip.
 - Do not attach the clip to hard material.
 - Do not use the clip by forcing it open.
 - Securely attach the clip all the way onto the material.
 - Do not apply excessive force while the clip is being used.
- A mark may remain on the material after the clip is used. Try using the clip in advance in an unnoticeable part of the material.
- Remove a dedicated attachment before opening the battery/card cover.

Recording

Recording

The voice recorder has five folders (Folder A to Folder E) in which recorded files can be saved. These folders provide a handy way to sort recordings into separate categories (such as business and leisure).

Basic recording procedure

- 1 Press the **▶▶** or **◀◀** button in the [Home] screen and select [Recorder] (P.21).
- 2 Press the **▶** OK button.
- 3 Press the **+** or **-** button to select the folder to save the recording in.

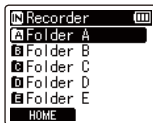
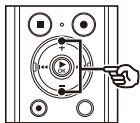

- Each new voice recording file is saved in the selected folder.

- 4 Point the built-in microphone in the direction of the sound to record.



- 5 Press the **REC** (●) button to start recording.

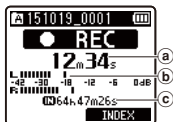
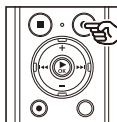

- a Elapsed recording time
 - b Level meter (changes according to recording volume and recording function setting)
 - c Remaining possible recording time
- The LED indicator light lights.
 - If you record simple recording content at the beginning, it will be convenient for searching later using the [Intro Play] function (P.66).

- 6 Press the **STOP** (■) button when you want to stop recording.

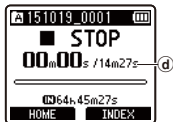
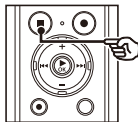

- d File length

Sound files recorded with the voice recorder are automatically given a file name in the format below.

151001_0001.MP3

①

②

③

① Date recorded

Indicates the year, month and day the recording was made.

② File number

Appended file numbers are consecutive regardless of whether the recording media has been switched.

③ Extension

A file extension indicating the recording format the file was recorded in by the voice recorder.

- Linear PCM format: **“.WAV”**
- MP3 format: **“.MP3”**

TIP

- **[Rec Mode]** must be set with the voice recorder stopped (☞ P.55).
- Pressing the **REC (●)** button starts recording even in **[Music]** or **[Calendar Search]** mode. So you will be able to respond quickly in the event of a sudden recording opportunity. The recorded file will be saved to **[Folder A]**.
- You can adjust the recording level manually to match your application (☞ P.54).

NOTE

- To prevent the beginning of the recording being cut off, start recording after the LED indicator light has lit or mode indicator has appeared in the display.
- When the remaining possible recording time is 60 seconds, the LED indicator light starts flashing. It flashes more rapidly as the remaining time decreases (at the 30- and 10-second points).
- When **[Folder full]** appears, no more recording can be done. To record more, you will need to select a different folder or delete unneeded files (☞ P.47).
- If **[Memory full]** appears, the voice recorder has no more available memory space. You will need to delete unneeded files to record more (☞ P.47).
- When using a microSD card in the voice recorder, be sure the desired recording media setting (**[Internal memory]** or **[microSD card]**) has been selected (☞ P.67).
- Processing performance may be reduced when data has been repeatedly written to or deleted from the recording media. Please initialize the recording media in this case (☞ P.88).

Recording linear PCM format files of over 2 GB

When recording a linear PCM format file, recording will continue even after the file size exceeds 2 GB.

- The data is divided and saved in separate files of up to 2 GB. The files are processed as multiple files during playback.
- After recording 200 files which exceed 2GB recording stops.

Pausing/resuming recording

- 1 Press the REC (●) button during recording.**

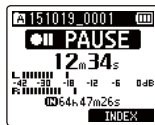
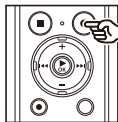

- Recording pauses, and the blinking message [● | PAUSE] appears in the display.
- Recording is stopped automatically after being paused for at least 60 minutes.

- 2 Press the REC (●) button again while recording is paused.**

- Recording resumes from the position it was paused at.

Quickly checking a recording

- 1 Press the ►OK button during recording.**

- Recording ends, and the file just recorded is played.

Recording settings

Various recording settings are available, letting you tailor recording to different recording conditions.

[Rec Level] (^{E32} P.54)	Sets the recording level.
[Rec Mode] (^{E32} P.55)	Sets the recording sound quality.
[Zoom Mic] (^{E32} P.55)	Sets the built-in stereo microphone's directivity.
[Low Cut Filter] (^{E32} P.56)	Reduces humming sounds from equipment such as air-conditioners or projectors.
[Mic Select] (^{E32} P.56)	Selects whether or not the built-in center microphone is to be turned on or off.
[VCVA] (^{E32} P.57)	Sets the trigger level for voice-activated recording (VCVA).
[V-Sync. Rec] (^{E32} P.58)	Sets the trigger level for voice-synchronized recording.
[Timer Rec] (^{E32} P.80)	Sets the content such as date and time to schedule a recording.
[Rec Scene] (^{E32} P.29)	Used to select one of multiple preregistered templates of recording settings. When selected, each template enters several settings tailored to a particular recording location or condition all in a single operation.

Monitoring while recording

You can monitor the recording as you are making it by listening on the earphones plugged into the voice recorder's earphone jack (🎧). Use the + or - button to adjust the recording monitor volume.

- The earphones are optional.

1 Connect the earphones to the voice recorder's earphone jack (🎧).

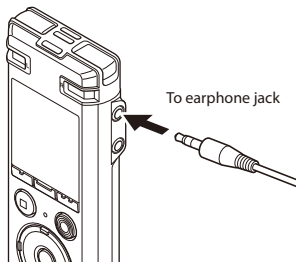

- Changing the volume will not affect the recording level.





NOTE

- To avoid unpleasantly loud sound, set the volume to [00] before plugging in the earphone.
- To prevent feedback, do not place the earphone near the microphone while recording.

Selecting the automatic recording setting [Rec Scene]

Changing the recording scene

The voice recorder has preregistered templates of optimum settings tailored to various recording applications such as lectures and dictation. When selecting one of these templates you can enter several settings recommended for your recording application all in a single operation.

[Lecture]  LECTURE	This is suitable for recording with the microphone pointed in a specific direction such as at a large venue where the speaker is far away.
[Conference]  CONF	Suitable for recording conferences in a large space and other sounds over a wide area.
[Meeting]  MEETING	Suitable for recording meetings held in a small space and other sounds that are fairly close.
[Dictation]  DICT	Suitable for recording your own voice and other sounds that are extremely close.
[DNS]  DNS	For Speech Recognition Software.

- 1** While the voice recorder is in stop mode, press and hold the MENU/SCENE button.

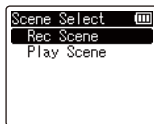

- 3** Press the + or - button to select the desired recording application.

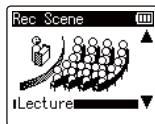
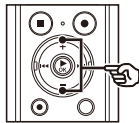

- 2** Press the ►OK button.

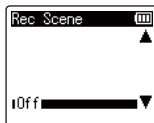
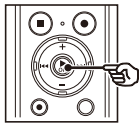

TIP

- You can press the ►►| button to display the settings of the selected template. Press the |◀◀ button to return to the [Rec Scene] screen.

Selecting the automatic recording setting [Rec Scene]

2

Selecting the automatic recording setting [Rec Scene]

4 Press the **▶OK** button to finalize the setting.

5 Press the **STOP** (■) button to exit the selection screen.

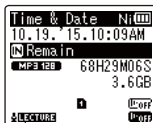
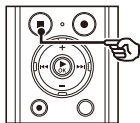

Rec Scene

- Press and hold the **STOP** (■) button when the recorder is stopped to check setting indicators meanings.

NOTE

- Recording menu settings cannot be changed when a [Rec Scene] selection has been made. To use these functions, you must select [Off] for the [Rec Scene] setting.

Preregistered [Rec Scene] settings

[Lecture]

[Rec Level]	[High]
[Rec Mode]	[MP3 128 kbps]
[Zoom Mic]	[+6]
[Low Cut Filter]	[On]
[Mic Select]	[Central Mic Off]
[VCVA]	[Off]
[V-Sync. Rec]	[Off]

[Conference]

[Rec Level]	[Auto]
[Rec Mode]	[MP3 128 kbps]
[Zoom Mic]	[Off]
[Low Cut Filter]	[On]
[Mic Select]	[Central Mic Off]
[VCVA]	[Off]
[V-Sync. Rec]	[Off]

[Meeting]

[Rec Level]	[Middle]
[Rec Mode]	[MP3 128 kbps]
[Zoom Mic]	[Off]
[Low Cut Filter]	[Off]
[Mic Select]	[Central Mic Off]
[VCVA]	[Off]
[V-Sync. Rec]	[Off]

Selecting the automatic recording setting [Rec Scene]

[Dictation]

[Rec Level]	[Low]
[Rec Mode]	[MP3 128 kbps]
[Zoom Mic]	[Off]
[Low Cut Filter]	[On]
[Mic Select]	[Central Mic Off]
[VCVA]	[Off]
[V-Sync. Rec]	[Off]

[DNS]

[Rec Level]	[Low]
[Rec Mode]	[MP3 128 kbps]
[Zoom Mic]	[Off]
[Low Cut Filter]	[Off]
[Mic Select]	[Central Mic Off]
[VCVA]	[Off]
[V-Sync. Rec]	[Off]

Recording with an external microphone

You can record audio input using an external microphone or other device connected to the voice recorder's microphone jack (🎧). Do not plug or unplug devices into voice recorder jacks while recording.

2

Recording with an external microphone

- 1 **Connect an external microphone to the voice recorder's microphone jack (🎧).**

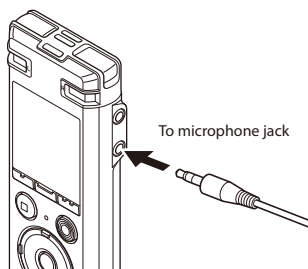

- 2 **Start recording.**

- See “**Recording**” (📖 P.25) for descriptions of recording operations.

TIP

- See “**Accessories (optional)**” (📖 P.103) for the compatible external microphones.

NOTE

- Microphones with plug-in power supplies can be used.
- When [**Rec Mode**] is set to stereo, recording with an external mono microphone records on the left channel only (📖 P.55).
- When [**Rec Mode**] is set to mono, only the input from the left channel microphone is recorded when using an external stereo microphone (📖 P.55).

Recording from another connected device

Recording audio from another device with this recorder

Audio can be recorded when you have connected the audio output terminal (earphone jack) of another device and the microphone jack (🎤) of the recorder by using the connecting cord KA333 (optional) for duplication.

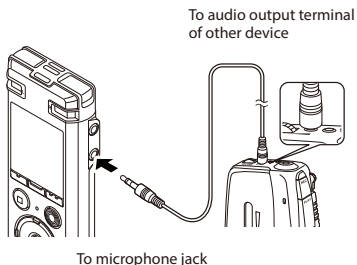

NOTE

- When recording from a connected external device, perform a test recording and adjust the output level of the connected device as needed.

Recording audio from this recorder with another device

Audio from this recorder can be recorded to another device by connecting the audio input terminal (microphone jack) of the other device and the earphones jack of this recorder using the connecting cord KA333 (optional).

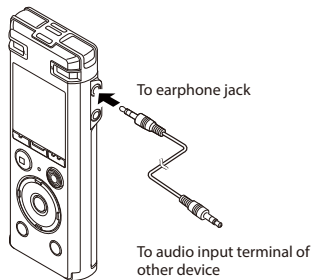

NOTE

- Adjusting playback sound quality settings on the voice recorder affects the audio output signals output from the earphones jack (P.60 to P.63).

Playback

Playback

In addition to files recorded by the voice recorder, you can also play files in WAV and MP3 format transferred from a PC.

Basic playback procedure

3



Playback

- 1 Select the file to play from the folder containing it (see P.22).

TIP

- Files are saved in the locations below.

Files recorded with the built-in microphone:

[Recorder] folders (folders  to )

Music files transferred from a PC:
[Music] folder

- 2 Press the **▶ OK** button to start playback.

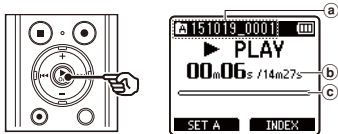

- Folder indicator / File name
- Elapsed playback time / File length
- Playback position bar indicator

- 3 Press the **+** or **-** button to adjust the volume to the desired level.

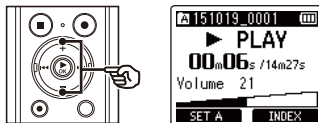

- The volume can be adjusted to a setting between [00] to [30]. The higher the number, the louder the volume.
- If the volume is set too loud, a warning screen may appear.

- 4 Press the **STOP** () button to stop playback.

- The file being played stops right away. The resume function automatically stores the playback stop position in memory. The position is retained even if the power is turned off. The next time the power is turned on, playback can be resumed from the stop position stored in the memory.

Fast-forwarding

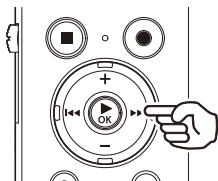

Fast-forwarding while the voice recorder is in stop mode

- 1 With the voice recorder stopped, press and hold the ►►| button.**
 - Fast-forwarding stops when you release the ►►| button. Press the ►OK button to start playback from the current position.

Fast-forwarding during playback

- 1 Press and hold the ►►| button during playback.**
 - Playback starts from the current position when you release the ►►| button.
 - If an index mark or temp mark in the file is reached, fast-forwarding stops at the mark (☞ P.45).
 - Fast-forwarding stops when the end of the file is reached. Press and hold the ►►| button again to fast-forward from the beginning of the next file.

Rewinding

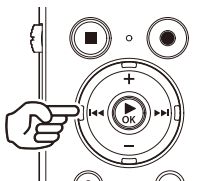

Rewinding while the voice recorder is in stop mode

- 1 With the voice recorder stopped, press and hold the ◀◀ button.**
 - Rewinding stops when you release the ◀◀ button. Press the ►OK button to start playback from the current position.

Rewinding during playback

- 1 Press and hold the ◀◀ button during playback.**
 - Playback starts from the current position when you release the ◀◀ button.
 - If an index mark or temp mark in the file is reached, rewinding stops at the mark (☞ P.45).
 - Rewinding stops when the beginning of the file is reached. Press and hold the ◀◀ button again to rewind from the end of the previous file.

Skipping to the beginning of a file

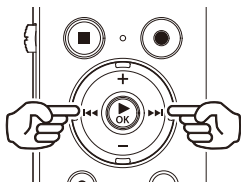

Skipping to the beginning of the next file

- 1 Press the **▶▶** button while the voice recorder is in stop mode, or during playback.

Skipping to the beginning of the current file

- 1 Press the **◀◀** button while the voice recorder is in stop mode, or during playback.

Skipping to the beginning of the previous file

- 1 Press the **◀◀** button when the playback position is the beginning of the file.
 - To skip to the beginning of the previous file during playback, press the **◀◀** button twice consecutively.

NOTE

- If an index mark or temp mark is reached when skipping to the beginning of a file during playback, playback starts from the position of the mark. When skipping to the beginning of a file while the voice recorder is in stop mode, the mark is ignored (E38 P.45).
- If a setting other than **[File Skip]** is set for **[Skip Space]**, playback starts after the set amount of time has been skipped backwards or forwards. Playback does not skip to the beginning of the file.

Playback settings

You can select various file playback methods tailored to different applications and tastes.

[Voice Playback]^{*1} (<small>ESP</small> P.60)	Only plays voice portions of a recorded audio file.
[Shadowing] (<small>ESP</small> P.60)	Plays segments of files, alternating repeatedly between playback and silence.
[Noise Cancel]^{*1} (<small>ESP</small> P.61)	A setting that makes recorded voices more discernable when muffled by projector noise or similar sounds.
[Voice Balancer]^{*1} (<small>ESP</small> P.61)	Compensates low-volume portions of recorded audio files during playback.
[Play Mode] (<small>ESP</small> P.62)	Selecting from among three playback modes.
[Equalizer]^{*2} (<small>ESP</small> P.63)	Adjusts the quality of sound as desired.
[Skip Space] (<small>ESP</small> P.63)	A handy function for quickly moving the playback position, and playing short segments repeatedly.
[Play Scene] (<small>ESP</small> P.39)	Switches to the playback operation setting. In this setting transcription can be made while listening to recorded content.

*1 Function active only in **[Recorder]** mode.

*2 Function active only in **[Music]** mode.

Playback through the earphones

You can connect the earphones to the voice recorder's earphone jack (🎧) and listen to playback through them.

- The earphones are optional.

1 Connect the earphones to the voice recorder's earphone jack (🎧).

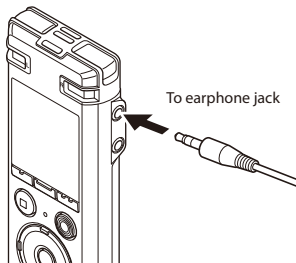

2 Press the ► OK button to start playback.

TIP

- There will be no sound from the speaker when the earphones are connected.

NOTE

- To avoid unpleasantly loud sound, set the volume to [00] before plugging in the earphone.
- Avoid excessive volume when listening to playback through the earphones. It may cause hearing damage or loss.
- If the volume is set too loud, a warning screen may appear.

Music files



If a music file transferred to the voice recorder is unplayable, check that its sampling rate, bit count and bit rate values are within the supported ranges. The sampling rate, bit count and bit rate combinations supported for music file playback by the voice recorder are shown below.

File format	Sampling rate	Bit count/ bit rate
WAV format	44.1 kHz, 48 kHz	16 bits
MP3 format	MPEG 1 Layer 3: 32 kHz, 44.1 kHz, 48 kHz MPEG 2 Layer 3: 16 kHz, 22.05 kHz, 24 kHz	8 to 320 kbps

- MP3 files with variable bit rates (bit rates converted variably in a single file) may not play normally.
- Linear PCM-format WAV files are the only WAV files the voice recorder can play. Playback of other WAV files is not supported.
- Even if the file formats is compatible for playback on this recorder, the recorder does not support every encoder.

Selecting the automatic playback operation [Play Scene]

You can set the optimum playback operation for transcription or language study. You can also use the fast or slow playback function at the same time.

[Transcription] 	This is convenient for creating the minutes and written records from audio files of meetings, interviews, and other events where multiple people speak.
[Language study] 	This is convenient for playing back conversations and language study content many times repeatedly.

- 1 While the voice recorder is in stop mode or playing a file, press and hold the MENU/SCENE button.**

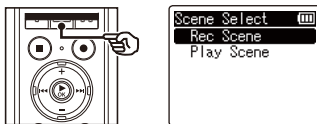

- If you pressed the **MENU/SCENE** button during playback, go to Step 4.

- 2 Press the + or – button to select [Play Scene].**

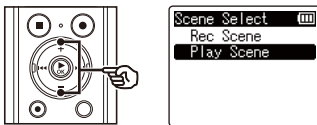

- 3 Press the ►OK button.**

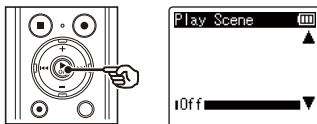

- 4 Press the + or – button to select the desired preset playback settings package.**

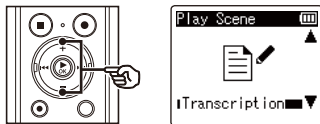

TIP

- You can press the ►► button to display the settings of the selected template. Press the ◀◀ button to return to the [Play Scene] screen.

- 5 Press the ►OK button to finalize the setting.**

TIP

- If you selected a preset playback settings template while the voice recorder is in stop mode, press the **STOP (■)** button to exit the menu screen.

Selecting the automatic playback operation [Play Scene]



Play Scene

- Press and hold the **STOP** (■) button when the recorder is stopped to check the setting indicators.

NOTE

- Playback menu settings cannot be changed when a playback scene selection has been made. To use these functions, you must select **[Off]** for the **[Play Scene]** setting.

Preregistered [Play Scene] settings

[Transcription]

[STOP (■)]	[Auto Back (3 sec)]
[▶▶I (CUE)]	[x3.5 Play Back]
[I◀◀ (REV)]	[Reviewing]
[▶▶I (SKIP)]	[10 sec. Skip]
[I◀◀ (SKIP)]	[3 sec. Skip]
[Voice Balancer]	[0n]

[Language study]

[STOP (■)]	[Stop]
[▶▶I (CUE)]	[x2.5 Play Back]
[I◀◀ (REV)]	[Reviewing]
[▶▶I (SKIP)]	[10 sec. Skip]
[I◀◀ (SKIP)]	[3 sec. Skip]
[Voice Balancer]	[0n]

Changing the playback speed

Changing the playback speed is handy for speeding up conference presentations, or for slowing down parts difficult to discern when learning a language.

- 1 Press the ►OK button during playback.

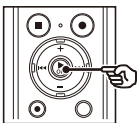

TIP

- When changing the playback speed, playback operations such as stopping playback, skipping to the beginning of a file, and writing index marks/temp marks are the same as during standard playback.

- 2 Press the + or – button.

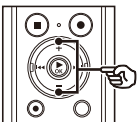

NOTE

- Altered playback speed settings are retained even after power OFF.
- Changing the playback speed will make the battery deplete more quickly.

- The playback speed can be adjusted between [x0.5 Play] and [x3.5 Play] in 0.1 increments.
- The playback speed increases when the + button is pressed, and decreases when the – button is pressed.
- To return to the normal playback speed, set the setting to [x1.0 Play].

- 3 Press the ►OK button to finalize the setting.

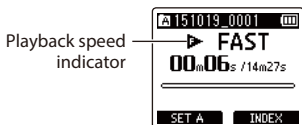

Fast playback restrictions

Depending on their sampling frequency and bit rate, some files may not play normally. In this case, you will need to reduce the playback speed.

ABC repeat playback

The voice recorder has a function with which you can repeat the playback of a portion (segment) of the file being played. In addition to the A-B repeat function available from previous models, the segment to repeat can be changed during repeat playback. There is also a shadowing playback function handy for language learning that can be used during ABC repeat playback. The **[Shadowing]** setting must be set to **[On]** before you can use the shadowing playback function (P.60).

3

ABC repeat playback

ABC repeat playback

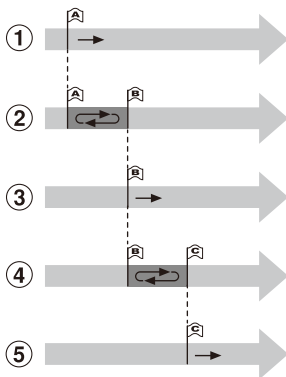



- 1 Select the starting point for repeat playback (A) during playback.
- 2 When the ending point (B) is selected, repeat playback starts.
- 3 When the starting point for repeat playback (A) is canceled during repeat playback, the ending point of the segment (B) becomes the new starting point and playback continues.
- 4 When the ending point (C) is selected, repeat playback starts again.

- 5 These steps can be repeated to re-specify a new segment to be played back repeatedly up to the end of the file.

- 1 Select a file for ABC repeat playback, and start playback.
- 2 Press the **F1 (SET A)** button when playback reaches the desired start position for ABC repeat playback.



- If **[Shadowing]** has been set, the  or  indicator appears.

ABC repeat playback

TIP

- You can change the playback speed (P.41), and fast-forward/rewind (P.35) when the [A] indicator is blinking.
- If playback reaches the end of the file when the [B] indicator is blinking, the end of the file is treated as the segment end position, and repeat playback starts.

- 3** Press the F1 (SET B) button again when playback reaches the desired end position for ABC repeat playback.



- Segment A-B is set, and ABC repeat playback starts.
- If [Shadowing] has been set, the repeat segment is played with the volume muted or lowered after it has been played at the usual volume. These operations are repeated until canceled.

Stopping ABC repeat playback:

Go to Step 6

Specifying new starting/ending points:

Go to Step 4

Specifying new starting/ending points

- 4** Press the F1 (CANCEL A) button during ABC repeat playback.



- Segment A-B is canceled. [B] becomes the new start position, and playback continues.
- You can change the playback speed (P.41), and fast-forward/rewind (P.35).
- The shadowing playback function is disabled.

- 5** Press the F1 (SET C) button at the desired end position for ABC repeat playback.



- Segment B-C is set, and ABC repeat playback starts.
- The shadowing playback function is enabled.

TIP

- You can repeat Steps 4 and 5 as needed to change the repeat segment as desired.

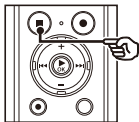
6 Press the STOP (■) button.

- Playback stops. The playback segment specified for this function is retained.

NOTE

- You cannot change the end position of a repeat playback segment to a position before the start position.
- You cannot write index marks or temp marks during ABC repeat playback (P.45).

Canceling ABC repeat playback**1 Press the F2 (CNCL ABC) button.**

- If pressed when ABC repeat playback is stopped, cancels ABC repeat playback.
- If pressed during ABC repeat playback, cancels the playback segment setting for the function, and continues standard playback.

NOTE

- If you change the file or switch to different display screen, ABC repeat playback is canceled.

Index marks/temp marks

Writing an index mark or temp mark in a file enables you to quickly access desired position in the file with the same operations used for fast-forwarding, rewinding or skipping to the start of a file. Index marks can only be written in files created with Olympus voice recorders. For files created with other devices, you can temporarily store desired positions in the memory using temp marks.

Writing an index mark/temp mark

- 1 When the desired position has been reached press the **F2 (INDEX)** button to write an index mark or temp mark.



NOTE

- Temp marks are temporary markings. They are automatically erased when you select a different file, transfer the file to a PC, or move the file on a PC.
- You can write up to 99 index marks/temp marks in a single file. The message **[No more can be set]** appears if you attempt to write more than 99 marks.
- You cannot write or erase index marks/temp marks in files that have been locked by the file lock function (P.52).

Erasing an index mark/temp mark

- 1 Select a file that contains index mark/temp mark you want to erase and start playback.
- 2 Use the **▶▶▶** or **◀◀◀** button to select the index mark/temp mark you want to erase.

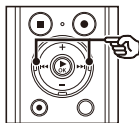

- 3 When the number of the index mark/temp mark to erase is being shown (for about 2 seconds) in the display, press the **ERASE** button.
 - Any subsequent index marks/temp marks in the file are automatically renumbered.

Calendar Search function

You can search for voice files by specifying a recording date. If you have forgotten in which folder a file has been saved, with this feature you can access it quickly by entering its recording date.

NOTE

- You can only search for files saved in [Recorder] folder.

- While the voice recorder is in stop mode, press the **F1 (HOME)** button to display the [Home] screen.
- Press the **▶▶▶** or **◀◀◀** button to select [Calendar Search].

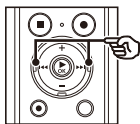

- Press the **▶OK** button.
- Press the **+, -, ▶▶▶** or **◀◀◀** button to select the desired date.

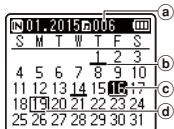
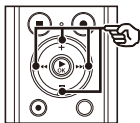

- Number of files saved (recorded) on selected date
- Date file was recorded
- Selected date
- Today's date

- Dates on which files were saved are underlined.

▶▶▶, ◀◀◀ button:

Move to the previous/next date. Press and hold to skip to the next date on which a file was recorded.

+, - button:

Move to the previous/next week.

F1, F2 button:

Move to the previous/next month.

- Press the **STOP** (■) button to cancel the setting and return to the [Home] screen.

- Press the **▶OK** button.

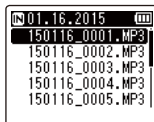
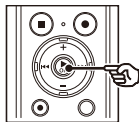

- Press the **+** or **-** button to select the desired file.
- Press the **▶OK** button to start playback.

Erasing files/folders

This section describes how to erase a single unneeded file from a folder, erase all the files in the current folder at once, or erase a selected folder.

Erasing files

- 1 Select the file you want to erase (see P.22).
- 2 When the file display screen appears, press the **ERASE** button while the voice recorder is in stop mode.



- The voice recorder returns to the stopped mode if no operation is performed for 8 seconds.

- 3 Press the **+** or **-** button to select **[All in folder]** or **[One file]**.



- [All in folder]:**
Erases all the files saved in the same folder as the selected file.
- [One file]:**
Erases only the selected file.

- 4 Press the **▶ OK** button.

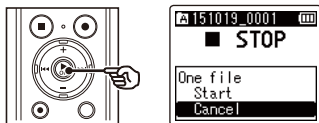

- 5 Press the **+** button to select **[Start]**.

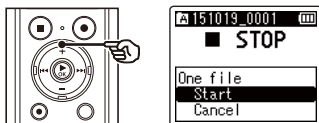

- 6 Press the **▶ OK** button.

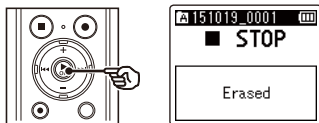

- **[Erasing!]** appears in the display, and the erasing process starts. **[Erased]** appears when the process has finished.

Erasing a folder

- 1 Select the folder you want to erase (☞ P.22).
- 2 In the folder display screen, press the ERASE button while the voice recorder is in stop mode.

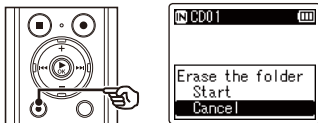

- The voice recorder returns to the stopped mode if no operation is performed for 8 seconds.

- 3 Press the + button to select [Start].

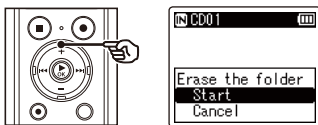

- 4 Press the ► OK button.
- [Erasing!] appears in the display, and the erasing process starts. [Erased] appears when the process has finished.

NOTE

- Files cannot be restored after being erased, so please check carefully before erasing a file.
- When there is a microSD in the voice recorder, be sure to check whether the recording media being erased is on the [Internal memory] or [microSD card] (☞ P.67).
- Locked files and read-only files cannot be erased (☞ P.52).
- The voice recorder's default [Recorder] folders ([FolderA] to [FolderE]) and [Music] folder cannot be erased.
- [Music] folder subfolders other than the [Music] can be erased.
- Files unrecognizable to the voice recorder will not be erased, nor will folders containing these files. The voice recorder must be connected to a PC to erase these files and folders.
- Before erasing a file or folder, charge or replace the battery to ensure it will not run out before the process has finished. Erasing processes can take over 10 seconds to complete. To prevent the risk of damage to data, never attempt to perform any of the following processes before an erasing process has finished :
 - ① Disconnecting the AC adapter
 - ② Removing the battery
 - ③ Removing the microSD card (if the recording media has been set to [microSD card]).

Menu

Setting menu items

Basic operation

Menu items are arranged by tabs, with which you can quickly set desired items by selecting a tab and then moving to the desired item within the tab. Follow the steps below to set a menu item.

- 1 During recording/playback or while the voice recorder is in stop mode, press the MENU/SCENE button.**

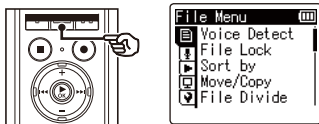

TIP

- Some menus contain items that can be set during recording/playback (☞ P.51).

- 2 Press the + or - button to select the tab containing the item you want to set.**

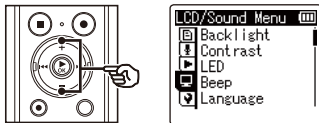

- Moving the cursor from one tab to another switches the displayed menu screen.

- 3 Press the ►OK button to move the cursor to the desired setting item.**

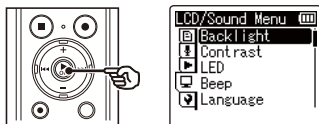

- You can also use the ►| button to perform this operation.

- 4 Press the + or - button to select the desired setting item.**

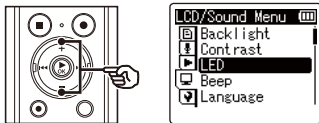

Setting menu items

Basic operation

5 Press the ►OK button.

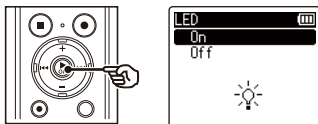

- The setting of the selected item is displayed.
- You can also use the ►► button to perform this operation.

6 Press the + or – button to change the setting.

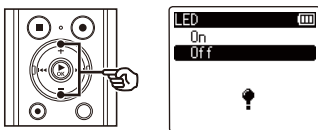

7 Press the ►OK button to finalize the setting.

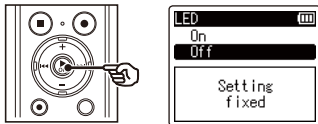

- A message indicating the setting has been entered appears.
- You can cancel the setting and return to the previous screen by pressing the ◀◀ button instead of the ►OK button.

8 Press the STOP (■) button to exit the menu screen.

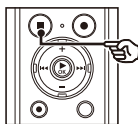

- When the menu screen is displayed during recording or playback, press the **MENU/SCENE** button to return to the previous screen without ending recording/playback.

NOTE

- For menu settings done while the voice recorder is in stop mode, the voice recorder exits the menu and returns to the stopped mode if no operation is performed for 3 minutes. The selected setting item is not changed in this case.
- For menu settings done during recording/playback, the voice recorder exits the menu if no operation is performed for 8 seconds.

Basic operation

■ Menu items that can be set during recording

- Rec Level
- Zoom Mic
- Low Cut Filter
- VCVA
- Backlight
- LED

■ Menu items that can be set during Playback

- Property
- Noise Cancel*1
- Voice Balancer*1
- Play Mode
- Equalizer*2
- Skip Space
- Backlight
- LED

*1 Function active only in [**Recorder**] mode.

*2 Function active only in [**Music**] mode.

File menu [File Menu]

4

File menu [File Menu]

Extracting the speaking portions of files of spoken-word content [Voice Detect]

The function extracts the speech portions of a voice file or a file being recorded by the voice recorder.

See “**Extracting speaking portions of files of spoken-word content [Voice Detect]**” (P.71) for more information.

Preventing accidental file erasure [File Lock]

With the file lock feature you can lock important files to prevent them being accidentally erased. Once locked, a file is not erased even if the operation for erasing all the files in its folder is performed (P.47).

1 Select the file you want to lock (P.22).

[Lock]:
File is locked.

[Unlock]:
File lock is canceled.

Sorting files [Sort by]

You can change the playback order of the files in a folder.

1 Press the + or – button to select [File name], [Date ascending] or [Date descending].

[File name]:
Automatically sorts the files by file name.

[Date ascending]:
Automatically sorts the files by date (recording time/date) from oldest to newest files.

[Date descending]:
Automatically sorts the files by date (recording time/date) from newest to oldest files.

2 Press the + or – button to select [Recorder] or [Music].

[Recorder]:
Sorts all the files in the [Recorder] folder.

[Music]:
Sorts all the files in the [Music] folder.

NOTE

- When [File name] is selected, files are listed in order of file name based on the first 20 characters of each name.

File menu [File Menu]

Moving/copying files [Move/Copy]

Files saved in the internal memory or on a microSD card can be moved or copied within memory.

See “**Moving/copying files [Move/Copy]**” (P.73) for the procedure.

Dividing files [File Divide]

Large files or files with long recording times can be divided for easier management and editing.

See “**Dividing a file [File Divide]**” (P.76) for the procedure.

Partially erasing files [Partial Erase]

You can erase unneeded parts of a file.

See “**Partially erasing files [Partial Erase]**” (P.78) for the procedure.

Displaying file or folder information [Property]

You can display the information of a file or folder from a menu screen.

File information

1 Press the + or – button to switch the screen.

- Information is displayed for the items **[Name]**, **[Date]**, **[Size]**, **[Bit Rate]**^{*1}, **[Artist]**^{*2} and **[Album]**^{*2}.

*1 If you selected a linear PCM-format file, the **[Bit Rate]** item displays the sampling frequency and bit count.

*2 If the file has no tag information, **[UNKNOWN_ARTIST]** and **[UNKNOWN_ALBUM]** are displayed.

Folder information

1 Press the + or – button to switch the screen.

- Information is displayed for the items **[Name]**, **[File]** (the number of files) and **[Folder]** (the number of folders).
- The **[Folder]** item is not displayed in **[Recorder]** mode.
- Displayed numbers of files do not include files in formats that are unrecognizable to the voice recorder.

Recording menu [Rec Menu]

Selecting the recording level [Rec Level]

You can change the recording level (sensitivity) as needed for your recording application.

[High]:

The highest recording sensitivity. Suited to recording lectures, large conferences and other applications with distant or quiet sound sources.

[Middle]:

Suited to recording discussions and small-group meetings.

[Low]:

The lowest recording sensitivity. Suited to recording dictation.

[Manual]:

Lets you set the recording sensitivity manually, to any of 30 levels.

[Auto]:

The recording level always automatically changes according to the volume of the input sound. Suited to recording all sounds.

TIP

- To record the speaker's voice clearly, set [Rec Level] to [Low], and place the voice recorder's built-in microphone near the speaker's mouth (5 to 10 cm away).

NOTE

- When [Rec Level] is set to other than [Manual], the recording level is adjusted automatically but noise may be generated if an excessively loud sound is input.

Adjusting the recording level

- 1 Adjust the recording level by pressing the **▶▶** or **◀◀** button during recording or when recording is paused.

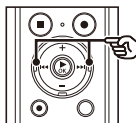

- Increasing the [Rec Level] number increases the recording level and extends the level meter indicator position.

NOTE

- Setting the voice recorder to [Manual] disables the limiter function. If [OV] is displayed, the recorded audio will be distorted. Adjust the recording level so that [OV] is not displayed.

Setting the recording mode [Rec Mode]

You can prioritize sound quality or recording time. Select the recording mode that best matches your recording application.

1 Press the + or – button to select the recording format.

[PCM]:

This is an uncompressed audio format which is used for music CDs etc.

[MP3]:

This is a common sound compression mode. File sizes in this format are smaller than in the PCM format.

2 Press the + or – button to select the recording rate.

When [PCM] was selected:

[48.0kHz/16bit]

[44.1kHz/16bit]

When [MP3] was selected:

[320kbps]

[128kbps]

[64kbps mono]*¹

[8kbps mono]*¹

*1 Mono recording

TIP

- Sound quality increases as the recording rate value increases.
- Setting a higher recording rate increases file size. Check that you have enough remaining memory before recording.
- To record conferences and presentations clearly, it is recommended to set [Rec Mode] to other than [mono].

NOTE

- When [Rec Mode] is set to stereo, recording with a connected mono microphone records on the left channel only.

Selecting microphone directivity [Zoom Mic]

The voice recorder's built-in stereo microphone provides directivity ranging from broad-coverage stereo recording to highly directional recording.

1 Press the + or – button to adjust the built-in stereo microphone's directivity.

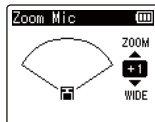
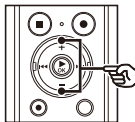

- The + button increases directivity.
- The – button enables recordings with broader-coverage stereo.
- Reducing directivity and broadening the sound pickup range gives recordings more of a stereo effect.
- The setting can be adjusted to between [-3] and [+6].

Recording menu [Rec Menu]

Zoom Mic function

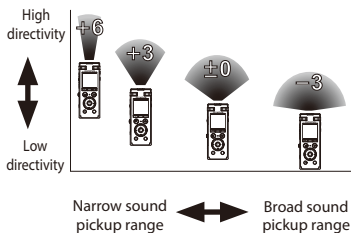

NOTE

- The **[Zoom Mic]** function has been set so as to optimize its performance when it is used with the voice recorder's built-in stereo microphone. Note that normal recording may no longer be possible when using a separately purchased microphone or when recording from another device using a connecting cord.
- Using the **[Zoom Mic]** function will make the battery deplete more quickly.

Reducing noise during recording [Low Cut Filter]

The voice recorder's low cut filter function lets you make recordings that reduce humming sounds from air-conditioners or low-frequency sounds from equipment such as projectors.

- [On]:**
Turns the low cut filter On.
- [Off]:**
Turns the low cut filter Off.

Selecting the three microphones system [Mic Select]

You can select whether or not the built-in center microphone is to be turned on or off.

- [Central Mic On]:**
Enables the built-in center microphone to record in three-microphone mode.
- [Central Mic Off]:**
Disables the built-in center microphone to record with just the built-in stereo microphone.

Voice-activated recording function [VCVA]

The voice-activated recording function (VCVA) automatically starts recording when a sound louder than a preset voice activation level is detected, and automatically pauses recording when the sound volume level falls. Use this function to automatically omit unneeded quiet segments when recording (such as long silences during conferences), saving memory.

[On]:
Turns VCVA On. You can adjust the voice activation level used for VCVA.

[Off]:
Turns VCVA Off. Restores standard recording.

Adjusting the voice activation level for voice-activated recording

1 Press the REC (●) button to start recording.

- Recording pauses automatically about 1 second after the input sound becomes quieter than the set activation sensitivity. The blinking message **[Standby]** appears in the display. The LED indicator light becomes lit when recording is activated and flashes when recording is paused.

2 Press the ►►| or |◀◀ button to adjust the voice activation level.

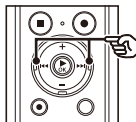

- a** Voice activation level (moves left/right to match set level)
- b** Level meter (changes in proportion to recording sound volume)
- The setting can be adjusted to between **[01]** and **[23]**.

TIP

- Increasing the setting number increases the VCVA activation sensitivity, enabling quieter sounds to activate the start of recording.
- Adjust the VCVA voice activation level to suit the recording conditions (to cope with high levels of surrounding noise or the like).
- To avoid recording mistake, it's recommended to perform a test recording beforehand to adjust the voice activation level.
- To change the recording level (Ⓔ P.54) during VCVA recording in [Manual], press the **F1** button. The voice recorder changes to recording level adjustment mode. Press the **F1** button again to return to voice activation level adjustment mode.

NOTE

- The following function is disabled when using the [VCVA] function:
 - [V-Sync. Rec]
 - [With recording] (Ⓔ P.71)

**Voice sync recording function
[V-Sync. Rec]**

The voice sync recording function automatically starts recording when a sound louder than a preset voice sync recording level (detection level) is detected, and automatically stops recording when the sound volume level decreases. When copying music from another device connected to the voice recorder, use the voice sync recording function to detect the silent intervals between music tracks and save each track as a separate file.

[1 sec.], [2 sec.], [3 sec.], [5 sec.]:

Set the detection time. The voice recorder enters standby mode when the input (recording level) is below the preset level for at least the set detection time.

[Off]:

Recording is done normally.

Adjusting the voice sync level for voice sync recording

- 1 Press the **REC (●)** button to prepare for recording.

Recording menu [Rec Menu]

- 2** Press the **▶▶** or **◀◀** button to adjust the voice sync level.

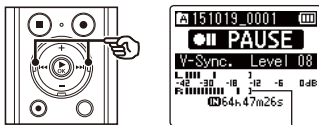

Voice sync level (moves left/right to match set level)

- The voice sync level can be adjusted to a setting between [01] and [23].
- Increasing the setting number increases the activation sensitivity, enabling quieter sounds to activate the start of recording.

TIP

- To change the recording level (P.54) during voice sync level adjustment in [Manual], press the **F1** button. The voice recorder changes to recording level adjustment mode. Press the **F1** button again to return to voice sync level adjustment mode.

- 3** Press the **REC** (●) button again.

- The blinking message [Standby] appears in the display, and the LED indicator light flashes.
- Recording starts automatically if the input is louder than the voice sync level.

TIP

- The voice recorder automatically ends recording and returns to recording standby mode when the input sound has been below the set voice sync level for at least the detection time. Each time the voice recorder enters standby mode, the current file is closed. Recording continues in a new file the next time sound is detected.
- Press the **STOP** (■) button to end a voice sync recording session.

NOTE

- The following function is disabled when using the [V-Sync. Rec] function:
 - [VCVA] (P.57)
 - [With recording] (P.71)

Setting timer recording [Timer Rec]

Recording starts automatically when the set time arrives.
See "Setting timer recording [Timer Rec]" (P.80) for the procedure.

Playback menu [Play Menu]

Skipping non-voice portions during playback [Voice Playback]

With the [Voice Playback] function you can only play the speaking portions of a recorded file of spoken-word content.

NOTE

- The speaking portions of the file must be extracted beforehand (☞ P.71).
- The [Voice Playback] function is only enabled in [Recorder] mode.

[On]:

Automatically skips the non-voice portions of the file and plays only the speaking portions.

[Off]:

The voice playback function is disabled.

Alternating repeatedly between normal and muted playback [Shadowing]

The voice recorder's shadowing playback function plays a repeat segment set for the ABC repeat playback function (☞ P.42) first at normal volume (for listening practice when learning a foreign language), and then a second time at muted or low volume (for speaking practice).

These two operations are repeated in alternation. This function is handy for use in language learning.

[Silent]:

Plays the repeat segment with the volume muted (silent) after playing it once at normal volume.

[Small volume]:

Plays the repeat segment at low volume after playing it once at normal volume.

[Off]:

Disables the shadowing playback function.

NOTE

- Shadowing playback only works with ABC repeat playback (☞ P.42).

Playback menu [Play Menu]

Reducing noise during playback [Noise Cancel]

Use the **[Noise Cancel]** function to reduce noise when a recorded voice is difficult to discern.

[High][Low]:

Reduces surrounding noise, producing higher sound-quality playback.

[Off]:

The noise cancel function is disabled.

NOTE

- **[Noise Cancel]** is only enabled in **[Recorder]** mode.
- Using the **[Noise Cancel]** function will make the battery deplete more quickly.

Adjusting low volume portions during playback [Voice Balancer]

Cuts low- and high-frequency components and compensates low-volume portions during playback.

Use it to make quiet parts of conversations or other recorded audio louder and clearer.

[On]:

Adjusts low-volume portions of audio files during playback, making them louder.

[Off]:

The voice balancer function is disabled.

NOTE

- **[Voice Balancer]** is only enabled in **[Recorder]** mode.
- Using the **[Voice Balancer]** function will make the battery deplete more quickly.

Playback menu [Play Menu]

4

Playback menu [Play Menu]

Selecting playback modes [Play Mode]

Several playback modes are available for different listening styles.

1 Press the + or – button to select [Recorder] or [Music].

When [Recorder] was selected

2 Press the + or – button to select [File] or [Folder].

[File]:

Stops playback after the current file has been played.

[Folder]:

Plays all the files in the current folder consecutively, stopping playback after the last file in the folder is played.

When [Music] was selected

2 Press the + or – button to select [Playback Range], [Repeat] or [Random].

[Playback Range]:

Lets you specify a range of files for playback.

[Repeat]:

Repeatedly plays the files in the set range.

[Random]:

Plays the files in the set range at random.

3 Press the + or – button to select a setting.

When [Playback Range] was selected:

[File], [Folder], [All]:

Specify the range of files for playback.

When [Repeat] or [Random] was selected:

[On]:

The files in the specified playback range are played repeatedly or at random.

[Off]:

Cancels repeat playback and random playback.

NOTE

- When [Playback Range] is set to [File], [End] blinks in the display for 2 seconds after the last file in the folder has been played, then playback stops at the start position of the last file.
- When [Playback Range] is set to [Folder], [End] blinks in the display for 2 seconds after the last file in the folder has been played, then playback stops at the start position of the first file in the folder.
- When [Playback Range] is set to [All], after the last file in the current folder has been played, the first file in the next folder is being played. When playback reaches the end of the last file in the voice recorder, [End] blinks in the display for 2 seconds, then playback stops at the start position of the first file in the voice recorder.

Changing music sound quality [Equalizer]

The voice recorder's equalizer settings can be changed to change music sound quality as desired.

When [User] was selected

- 1 Press the **▶▶|** button.
- 2 Press the **▶▶|** or **|◀◀** button to select a frequency band.
 - You can set different levels for the [60 Hz], [250 Hz], [1 kHz], [4 kHz] and [12 kHz] frequency bands.
- 3 Press the **+ or -** button to set a level.
 - Levels can be set to values between [-6] and [+6], in 1 dB increments.
 - Increasing a level setting emphasizes the corresponding frequency band.
 - To change another frequency band, repeat Steps 2 and 3.

NOTE

- [Equalizer] function is only enabled in [Music] mode.

Setting a skip space [Skip Space]

The [Skip Space] function lets you skip a preset amount forward (forward skip) or backward (reverse skip) in a file during playback. It is handy for quickly moving the playback position, or for repeated playback of a short segment.

- 1 Press the **+ or -** button to select [Forward Skip] or [Reverse Skip].

[Forward Skip]:
Starts playback after moving the playback position forward by the set amount.

[Reverse Skip]:
Starts playback after moving the playback position backward by the set amount.
- 2 Press the **+ or -** button to select a setting.

When [Forward Skip] was selected:

[File Skip], [10 sec. Skip], [30 sec. Skip],
[1 min. Skip], [5 min. Skip], [10 min. Skip]

When [Reverse Skip] was selected:

[File Skip], [1 sec. Skip] to [3 sec. Skip],
[5 sec. Skip], [10 sec. Skip], [30 sec. Skip],
[1 min. Skip], [5 min. Skip]

NOTE

- Forward/reverse skip operations over a skip space that contains an index mark/temp mark or the starting position of a file will stop at that mark or at the start position.

Forward/reverse skip playback

4

1 Press the ►OK button to start playback.

2 Press the ►►| or |◄◄ button during playback.

- Playback starts after skipping forward or backward by the set amount.

LCD/Sound menu [LCD/Sound Menu]

Setting the backlight [Backlight]

The display backlights are switched on for a preset amount of time when a button operation is performed.

[5 sec.], **[10 sec.]**, **[30 sec.]**, **[1 min.]**:

Set the amount of time that the backlight stays lit.

[Off]:

Disables the backlight.

Adjusting the contrast [Contrast]

You can adjust the contrast of the display to 12 different levels.

- The setting can be adjusted to between **[01]** to **[12]**.

Setting the LED indicator light [LED]

You can set the LED indicator light to not become lit.

[On]:

LED indicator light is switched on.

[Off]:

LED indicator light stays off.

TIP

- Even if you set the **[LED]** setting to **[Off]**, the LED indicator light will flash while files are being transferred between the voice recorder and a PC.

Turning beeping sound on/off [Beep]

The voice recorder makes beeping sounds when buttons are pressed, or to warn in case of operation errors. You can select whether the voice recorder makes these beeping sounds.

[On]:

Enables beeping sounds.

[Off]:

Disables beeping sounds.

Changing the display language [Language]

You can select the language used in the voice recorder's displays.

- **[English]**, **[Español]**, **[Français]**, **[繁體中文]**.

TIP

- The language selections vary depending on where the voice recorder was purchased.

LCD/Sound menu [LCD/Sound Menu]

Setting the voice guidance [Voice Guide]

This feature gives voice announcements of recorder operating conditions.

See “**Setting the voice guidance [Voice Guide]**” (P.84) for the procedure.

Playing the beginning of files automatically [Intro Play]

Each time you select a file in the file list screen, the voice recorder can automatically play a few seconds of the beginning of the file. This function is convenient for searching for a file because it allows you to check the content of files.

[3 sec.], [5 sec.], [10 sec.]:

Each time you select a file, the beginning part will be played automatically.

[Off]:

Turns **[Intro Play]** off.

Selecting the speaker output [Speaker]

You can set the built-in speaker to be On or Off when the earphones are not connected. When set to **[Off]**, sound will not be output from the speaker even if the earphones are accidentally disconnected. Use this setting to prevent possible embarrassment on public transport.

[On]:

The voice recorder's playback sound is output from the earphones when the earphones are connected, or from the built-in speaker when the earphones are not connected.

[Off]:

The voice recorder's playback sound is not output from the built-in speaker even if the earphones are disconnected.

Device menu [Device Menu]

Selecting the recording media [Memory Select]

If a microSD card is inserted into the voice recorder, you can select whether to use the internal memory or the microSD card (see P.17).

[Internal memory]:

Uses on the internal memory on the voice recorder.

[microSD card]:

Uses on the microSD card.

Setting power save mode [Power Save]

The voice recorder turns Off automatically when a preset amount of time has elapsed with the voice recorder stopped after power On.

[5 min.], [10 min.], [30 min.], [1 hr.]:

Select the desired amount of time.

[Off]:

Disables power save mode. Note that leaving the voice recorder On will quickly deplete the battery.

Setting the battery in use [Battery]

Set the battery type to match the battery you are using.

[Ni-MH]:

Select this setting when using an Olympus Ni-MH rechargeable battery (model BR404).

[Alkaline]:

Select this setting when using an alkaline dry cell battery.

Setting the time/date [Time & Date]

If you set the date and time, you will be able to check when a file was recorded in the information for each file accessed from [Property] of the menu.

- 1 Press the **▶▶▶** or **◀◀◀** button to select the desired setting item.

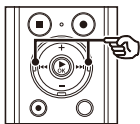

- 2 Press the **+** or **-** button to change the number.

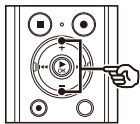

- To change the setting of another item, press the **▶▶▶** or **◀◀◀** button to move the blinking cursor, then press the **+** or **-** button to change the number.

- 3 Press the **▶OK** button to finalize the setting.

TIP

- When setting the hour or minute, each time you press the **F2** button the display changes between the AM/PM and 24-hour clock formats.

Example: 10:38 PM

10:38 PM
(default format) ↔ 22:38

- When setting the year, month or date, each time you press the **F2** button the display order used for the date changes.

Example: March 24, 2015

3M 24D 2015Y
(default format)

↓
24D 3M 2015Y

↓
2015Y 3M 24D

NOTE

- If the batteries are removed from the voice recorder, the [Time & Date] screen is displayed automatically when the power is turned on.
- Even if the voice recorder is not used for a long period of time, when the battery is used up, the date and time must be re-entered.

Setting the USB connection [USB Settings]

The [PC] setting lets you connect the voice recorder to a PC to transfer files. The [AC Adapter] setting lets you connect the voice recorder to a USB-connection AC adapter (model A514; optional) or a PC to charge the rechargeable battery. You can change the USB class setting as required by different USB applications.

See “Setting the USB connection [USB Settings]” (P.86) for the procedure.

Restoring the default settings [Reset Settings]

The [Reset Settings] function restores all the voice recorder’s functions to their initial (factory default) settings. Time setting and file number will remain the same.

1 Press the + button to select [Start].

Rec Menu:

Rec Level: Middle
Rec Mode: MP3 128kbps
Zoom Mic: Off
Low Cut Filter: Off
Mic Select: Central Mic On
VCVA: Off
V-Sync. Rec: Off
Timer Rec: Off
Rec Scene: Off

Play Menu:

Voice Playback¹: Off
Shadowing: Off
Noise Cancel¹: Off
Voice Balancer¹: Off
Play Mode:
Recorder:
Playback Range / File
Music:
Playback Range / Folder
Repeat / Off
Random / Off
Equalizer²: Off
Skip Space:
Forward Skip: File Skip
Reverse Skip: File Skip
Play Scene: Off

LCD/Sound Menu:

Backlight: 10 sec.
Contrast: Level 06
LED: On
Beep: On
Language: English
Voice Guide:
On/Off: On
Speed: 3
Volume: 3
Intro Play: Off
Speaker: On

Device Menu:

Memory Select: Internal memory
Power Save: 10 min.
Battery: Ni-MH
USB Settings:
USB Connection: PC
USB Class: Storage Class

*1 Function active only in [Recorder] mode.

*2 Function active only in [Music] mode.

Formatting a recording media [Format]

Formatting a recording media erases all existing files saved on it. Be sure to transfer all important files to a PC before formatting.

See “**Formatting recording media [Format]**” (P.88) for the procedure.

Checking voice recorder information [System Info.]

You can display voice recorder information from a menu screen.

- The voice recorder’s **[Model]**, **[Version]** (system version) and **[Serial No.]** information is displayed.

Checking recording media information [Memory Info.]

You can display the capacity and remaining memory space of the recording media from a menu screen.

NOTE

- Some recording media memory capacity is used as a management area, so the actual usable capacity will always be slightly less than the displayed capacity.

Extracting the speaking portions of files of spoken-word content [Voice Detect]

The function extracts the speech portions of a voice file or a file being recorded by the voice recorder.

NOTE

- The [Voice Detect] function can only be used in [Recorder] mode.
- To extract the speech portion from saved files, select a folder from [F1] to [F6] in the [Recorder] folder beforehand.

- 1 Press the MENU/SCENE button while the voice recorder is in stop mode.
- 2 Press the ►OK button to move the cursor into the list of setting items.
- 3 Press the ►OK button.
- 4 Press the + or - button to select [File select] or [With recording].

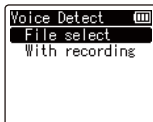
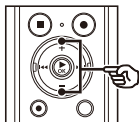

[File select]:

Select a file for which you want to extract the speech portion.

[With recording]:

Extract the speech portion while recording.

- 5 Press the ►OK button to move to the respective setting.

When [File Select] is selected

- 1 Press the + or - button to select the desired file in which you want to detect voice.

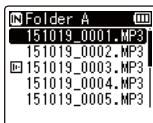

- 2 Press the ►OK button.
- The progress of the operation is shown as a percentage in the display.
 - [Voice Detection completed] appears when the process has finished.

Extracting the speaking portions of files of spoken-word content [Voice Detect]

When [With recording] is selected

- 1 Press the + or – button to select [On] or [Off].

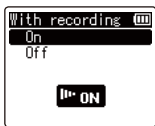

[On]:

Extract the speech portion while recording.

[Off]:

Restores standard recording.

- 2 Press the ►OK button.
- [Setting fixed] appears when the process has finished.

6 Press the STOP (■) button to exit the menu screen.

TIP

- When the voice detection process has finished, the [Voice Playback] item in the [Play Menu] is set to [On] (☞ P.60).

NOTE

- The message [No file] appears if you select a folder that doesn't contain a saved file. You must select a folder containing a file before you can perform the process.
- The voice recorder may not be able to properly extract non-silent portions from files of non-spoken word content such as recorded musical performances.
- The voice recorder may not be able to properly extract speaking portions when they were low in volume when recorded (level meter readout of -12 dB or less), or due to surrounding noise.
- The time needed for the extraction process will increase in proportion to the size of the recorded file. Before starting extraction, it's recommended to charge or replace the battery to ensure it will not run out before the process has finished.
- Using the [With recording] function will make the battery deplete more quickly.
- The following functions are disabled when using the [With recording] function:
 - [VCVA] (☞ P.57)
 - [V-Sync. Rec] (☞ P.58)

Moving/copying files [Move/Copy]

Files saved in the internal memory or on a microSD card can be moved or copied within memory.

- 1 Before performing the move/copy operation, first select the folder containing the file you want to move or copy (see P.22).**
- 2 Press the MENU/SCENE button while the voice recorder is in stop mode.**
- 3 Press the ► OK button to move the cursor into the list of setting items.**
- 4 Press the + or – button to select [Move/Copy].**
- 5 Press the ► OK button.**
- 6 Press the + or – button to select the desired file movement/copying method.**

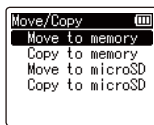
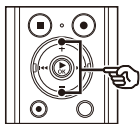

[Move to memory]:

Moves one or more files saved in the internal memory or inserted microSD card to a different folder in the internal memory.

[Copy to memory]:

Copies one or more files saved in the internal memory or inserted microSD card to a different folder in the internal memory.

[Move to microSD]:

Moves one or more files saved in the internal memory or inserted microSD card to a different folder in the microSD card.

[Copy to microSD]:

Copies one or more files saved in the internal memory or inserted microSD card to a different folder in the microSD card.

- 7 Press the ► OK button.**
- 8 Press the + or – button to select the number of files to move or copy.**

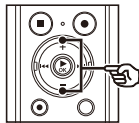

[One file]:

Selects only the specified file.

[Selected files]:

Selects multiple files.

[All files]:

Selects all the files in the folder.

Moving/copying files [Move/Copy]

- 9 Press the **▶OK** button to continue to the next setting.

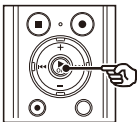

- ② Repeat Step ① to select all the files you want to move or copy, then press the **F2** button.

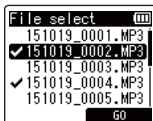

When [One file] was selected

- ① Press the **+** or **-** button to select the file to move or copy, then press the **▶OK** button.

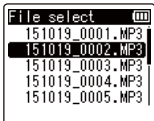

When [All files] was selected

All the files in the current folder are selected automatically, and the display switches to the [Destination] screen.

- 10 Press the **+**, **-**, **▶▶** or **◀◀** button to select the folder to move or copy the files to.

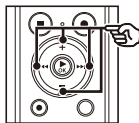

When [Selected files] was selected

- ① Press the **+** or **-** button to select a file to move or copy, then press the **▶OK** button.

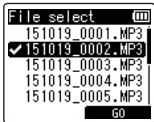

TIP

- Files cannot be moved or copied directly within the [Recorder] folder. Press the **▶▶** or **◀◀** button to select a folder from **F1** to **F6** folder in the [Recorder] folder.

TIP

- You can deselect a previously selected file by selecting it and pressing the **▶OK** button again.

11 Press the F2 button.

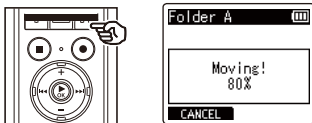

- The progress of the operation is shown as a percentage in the display.
- **[File move completed]** or **[File copy completed]** appears when the process has finished.

TIP

- Locked files (P.52) remain locked after being moved or copied.

NOTE

- Files cannot be copied if there is insufficient remaining memory.
- Files cannot be moved or copied if there are over 200 files.
- To prevent the risk of data damage, never remove the battery while moving or copying a file.
- Files cannot be moved or copied within the same folder.
- When a file moving or copying process is canceled before completion, the files that completed the process will have been moved or copied, and process is canceled for the other files.

Dividing files [File Divide]

Large files or files with long recording times can be divided for easier management and editing.

NOTE

- Only MP3-format and PCM-format files recorded on the voice recorder can be divided.

- 1 Before performing the file dividing operation, first select the file you want to divide** (☞ P.22).
- 2 Press the MENU/SCENE button while the voice recorder is in stop mode.**
- 3 Press the ►OK button to move the cursor into the list of setting items.**
- 4 Press the + or – button to select [File Divide].**
- 5 Press the ►OK button.**
- 6 Press the ►OK button and play the file to the desired division point** (☞ P.34).
 - You can change the playback speed (☞ P.41), and fast-forward/rewind (☞ P.35).

TIP

- Writing an index mark/temp mark at the division point beforehand is handy (☞ P.45).

- 7 Press the F2 button at the desired division point.**



- 8 Press the + button to select [Start].**

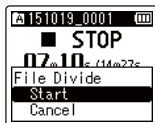
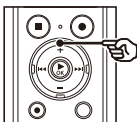

- 9 Press the ►OK button.**

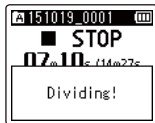
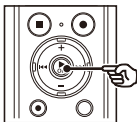

- 10 Press the STOP (■) button to exit the menu screen.**
- [Dividing!] appears in the display, and the file dividing process starts.
[File divide completed] appears when the process has finished.

TIP

- After dividing a file, the first half of the file is given the name "**File name_1**" and the second half "**File name_2**".

NOTE

- [**File Divide**] can be performed only when the file list is displayed.
- Files cannot be divided if there are 200 files in the folder.
- Locked files (Ⓜ P.52) cannot be divided.
- It may not be possible to divide some MP3 or PCM files with extremely short recording times.
- To prevent the risk of data damage, never remove the battery while dividing a file.

Partially erasing files [Partial Erase]

You can erase unneeded parts of a file.

NOTE

- Only PCM-format file recorded on the voice recorder can be erased.

1 Before performing the file erasing operation, first select the file you want to erase (☞ P.22).

2 Press the MENU/SCENE button while the voice recorder is in stop mode.

3 Press the ►OK button to move the cursor into the list of setting items.

4 Press the + or – button to select [Partial Erase].

5 Press the ►OK button.

6 Press the ►OK button to play the file to the desired erasing point (☞ P.34).

- You can change the playback speed (☞ P.41), and fast-forward/rewind (☞ P.35).

7 Press the F2 button at the partial erase start position.



TIP

- Playback continues while [Start] position is set and as with usual playback, changing the playback speed and fast-forward/rewind can be performed and you can quickly advance to the [End] position.
- When the end of the file is reached while the [End] position is not set, that position becomes the end position of erase.
- Writing an index mark/temp mark at the start point and end point beforehand is handy (☞ P.45).

8 Press the F2 button again at the position where you want to end partial erase.

Partially erasing files [Partial Erase]

- 9 Press the + button to select [Start].

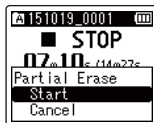
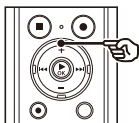

- 10 Press the ► OK button.

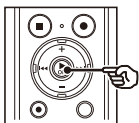

- [Partial erasing!] appears in the display, and the file erasing process starts.
[Partial erase completed] appears when the process has finished.

- 11 Press the STOP (■) button to exit the menu screen.

NOTE

- Files cannot be restored after being erased, so please check carefully before erasing a file.
- Locked files and read-only files cannot be erased (refer P.52).
- Before erasing a file or folder, charge or replace the battery to ensure it will not run out before the process has finished. Erasing processes can take over 10 seconds to complete. To prevent the risk of damage to data, never attempt to perform any of the following processes before an erasing process has finished :
 - ① Disconnecting the AC adapter
 - ② Removing the battery
 - ③ Removing the microSD card (if the recording media has been set to [microSD card]).

Setting timer recording [Timer Rec]

Start recording automatically when a set time is reached. Timer recording allows you to record at a set date and time as well as record at specific periods such as the following day or following week based on that set date and time. You can register up to three reservation settings.

NOTE

- Check beforehand that the voice recorder clock matches the current date and time. If the current date/time is set incorrectly, see “**Setting the time/date [Time & Date]**” (P.68).
- Timer recording operates with the content set in the voice recorder. The settings required for recording need to be completed beforehand. The possible recording time and amount of battery consumption may vary depending on the settings (P.28).
- Check that there is sufficient battery life. Replace or charge the battery if needed (P.9, P.12).
- Check that there is sufficient remaining memory space. Erase unneeded files or use a new microSD card if needed (P.47, P.17).
- The save destination for the recorded file can be selected from [Folder A] to [Folder E]. Note that timer recording will not be performed if there are already 200 files in the save destination folder. If necessary, delete any files you do not need or select another folder (P.22).
- Timer recording may start a few seconds after the set time arrives.

- 1 Press the MENU/SCENE button while the voice recorder is in stop mode.**
- 2 Press the + or – button to select the [Rec Menu] tab.**
- 3 Press the ►OK button to move the cursor into the list of setting items.**
- 4 Press the + or – button to select [Timer Rec].**
- 5 Press the ►OK button.**
- 6 Press the + or – button to select the desired preset number.**

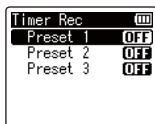
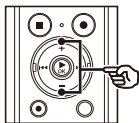

- 7 Press the ►OK button.**

Setting timer recording [Timer Rec]

- 8** Press the **+** or **-** button to select the desired setting item.

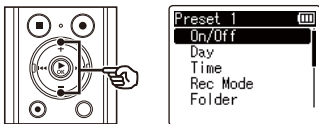

[On/Off]:

Turns the selected reservation on or off.

[Day]:

Sets the repeat interval of the reservation.

[Time]:

Sets the start time and end time of the reservation.

[Rec Mode]:

Sets the recording format.

[Folder]:

Sets the save destination folder for timer recording (Folder A to Folder E).

[Rec Level]:

Sets the recording level.

- 9** Press the **▶OK** button to continue to the next setting.

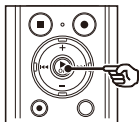

When [On/Off] was selected

- ① Press the **+** or **-** button to select **[On]** or **[Off]**.

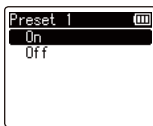

[On]:

Timer recording is performed according to the registered settings.

[Off]:

Timer recording is not performed.

- ② Press the **▶OK** button to exit the selection screen.

When [Day] was selected

- ① Press the **+** or **-** button to select **[One Time]**, **[Every Day]** or **[Every Week]**.



[One Time]:

Records at the specified date and time and ends.

[Every Day]:

After recording on the specified date and time, repeats recording at the same time every day.

[Every Week]¹⁾:

After recording on the specified date and time, repeats recording at the same time each week.

Setting timer recording [Timer Rec]

- Press the ►OK button to exit the selection screen.
- *1 If you select [Every Week] and then press the ►OK button, a screen for selecting the day of the week to perform the reservation appears.



Press the + or - button to select the day on which to perform the reservation every week and then press the ►OK button.

When [Time] was selected

- Press the + or - button to change the number.



- Press the ►►| button to move the cursor.
- Repeat steps ① and ② to set the time.
- Press the ►OK button to exit the selection screen.

When [Rec Mode] was selected

- Press the + or - button to select [PCM] or [MP3], then press the ►OK button.

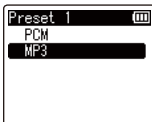

- Press the + or - button to select the recording rate.
- Press the ►OK button to exit the selection screen.

When [Folder] was selected

- Press the + or - button to select the media to save the recording in, then press the ►OK button.



- Press the + or - button to select the folder to save the recording in.

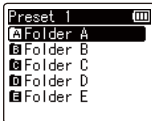

- Press the ►OK button to exit the selection screen.

Setting timer recording [Timer Rec]

When [Rec Level] was selected

- 1 Press the + or - button to select [High], [Middle], [Low], [Manual] or [Auto].

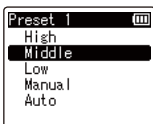

- 2 Press the ►OK button to exit the selection screen.

10 Press the ◀◀ button to exit the reservation screen.

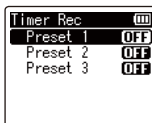
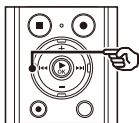

- After you have finished in the reservation settings screen, you can press the ►► button to check the settings for the selected reservation number. Press the ◀◀ button to return to the reservation number list screen.

11 Press the STOP (■) button to exit the menu screen.

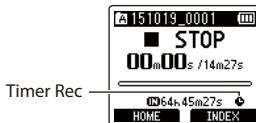

TIP

- Even though the power is OFF or on hold, when the specified [Timer Rec] time arrives, recording starts.
- If the [Start Time] settings are the same, [Preset 1] has the highest priority and [Preset 3] has the lowest priority.

NOTE

- If voice recording is in progress or the unit is in use when the [Timer Rec] start time arrives, [Timer Rec] starts after the operation is finished.
- If a microSD card is set as the file save destination and the microSD card is not inserted when timer recording is performed, the file is recorded to [Folder A] in the internal memory.

Setting the voice guidance [Voice Guide]

This feature gives voice announcements of recorder operating conditions. You can set voice announcement On/Off, speed and volume.

4

Setting the voice guidance [Voice Guide]

- 1 Press the **MENU/SCENE** button while the voice recorder is in stop mode.
- 2 Press the **+** or **-** button to select the **[LCD/Sound]** tab.
- 3 Press the **▶OK** button to move the cursor into the list of setting items.
- 4 Press the **+** or **-** button to select **[Voice Guide]**.
- 5 Press the **▶OK** button.
- 6 Press the **+** or **-** button to select **[On/Off]**, **[Speed]** or **[Volume]**.

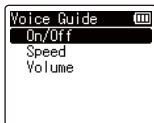
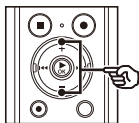

- [On/Off]:**
Switches voice guidance On/Off.
- [Speed]:**
Sets the voice guidance speed.
- [Volume]:**
Sets the voice guidance volume.

- 7 Press the **▶OK** button to move to the respective setting.

When [On/Off] was selected

- 1 Press the **+** or **-** button to select **[On]** or **[Off]**.

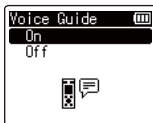

- [On]:**
Voice guidance will be enabled.
- [Off]:**
Voice guidance will be canceled.

- 2 Press the **▶OK** button to exit the selection screen.

When [Speed] was selected

- 1 Press the **+** or **-** button to select the voice speed.

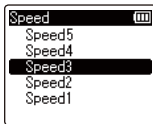

- [Speed1] to [Speed5]:**
The greater the number, the faster the speed.
- 2 Press the **▶OK** button to exit the selection screen.

Setting the voice guidance [Voice Guide]

When [Volume] was selected

- 1 Press the + or – button to select the voice volume.

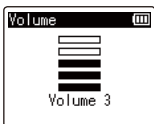

[Volume1] to [Volume5]:

The greater the number, the louder the beep sound.

- 2 Press the ►OK button to exit the selection screen.

8 Press the STOP (■) button to exit the menu screen.

NOTE

- During playback of a file, the [Speed] setting of [Voice Guide] is disabled.

Setting the USB connection [USB Settings]

The [PC] setting lets you connect the voice recorder to a PC to transfer files. The [AC Adapter] setting lets you connect the voice recorder to a USB-connection AC adapter (model A514; optional) or a PC to charge the rechargeable battery. You can change the USB class setting as required by different USB applications.

1 Press the MENU/SCENE button while the voice recorder is in stop mode.

2 Press the + or – button to select the [Device Menu] tab.

3 Press the ►OK button to move the cursor into the list of setting items.

4 Press the + or – button to select [USB Settings].

5 Press the ►OK button.

6 Press the + or – button to select [USB Connection] or [USB Class].

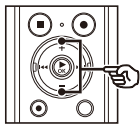

[USB Connection]:

Used to set connection to a PC.

[USB Class]:

Used to set the USB class.

7 Press the ►OK button.

When [USB Connection] was selected

➤ Go to Step 8

When [USB Class] was selected

➤ Go to Step 10

TIP

- If the voice recorder is not recognized by the PC as an external memory device, select [Storage Class] for [USB Class].
- If [AC Adapter] is selected for [USB Connection], the voice recorder will not be recognized if connected to a PC.

Setting the USB connection [USB Settings]

When [USB Connection] was selected

- 8** Press the + or – button to select a setting.

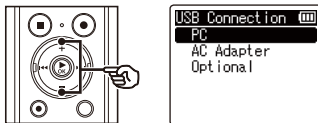

[PC]:
Select to connect the voice recorder to a PC. The voice recorder will be connected as a storage or composite device.

[AC Adapter]:
Select to charge the rechargeable battery from a PC, or to connect the voice recorder to an AC adapter (model A514; optional).

[Optional]:
Select to confirm the connection method whenever making a USB connection.

- 9** Press the ►OK button, and go to Step 12.

When [USB Class] was selected

- 10** Press the + or – button to select a setting.

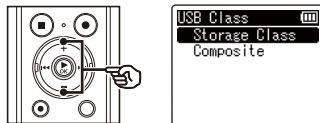

[Storage Class]:
Select to have the voice recorder recognized as an external memory device by a connected PC.

[Composite]:
Select to have the voice recorder recognized as an external memory device by a connected PC, and to use the voice recorder as a USB speaker/microphone.

- 11** Press the ►OK button.
- 12** Press the STOP (■) button to exit the menu screen.

Formatting recording media [Format]

Formatting a recording media erases all existing files saved on it. Be sure to transfer all important files to a PC before formatting.

4

Formatting recording media [Format]

- 1 Press the **MENU/SCENE** button while the voice recorder is in stop mode.
- 2 Press the **+** or **-** button to select the **[Device Menu]** tab.
- 3 Press the **▶OK** button to move the cursor into the list of setting items.
- 4 Press the **+** or **-** button to select **[Format]**.
- 5 Press the **▶OK** button.
- 6 Press the **+** or **-** button to select the recording media to be formatted.
- 7 Press the **▶OK** button.
- 8 Press the **+** button to select **[Start]**.

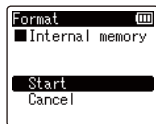
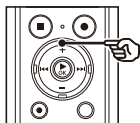

- 9 Press the **▶OK** button.

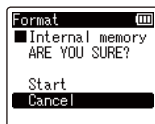
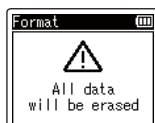
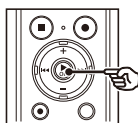

- 10 Press the **+** button to select **[Start]** again.
- 11 Press the **▶OK** button.

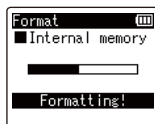
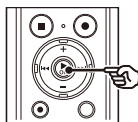

- **[Formatting!]** appears, and formatting starts.
- **[Format done]** appears when the process has finished.

TIP

- To reset all the voice recorder's settings to their default values, use the **[Reset Settings]** operation (P.69).

NOTE

- Never format the voice recorder from a PC.
- Formatting erases all the existing data, including locked files and read-only files.
- If there is a microSD card in the voice recorder, make sure **[Internal memory]** or **[microSD card]** has been correctly selected as the recording media to erase (☞ P.67).
- Before formatting, charge or replace the battery to ensure it will not run out before the process has finished. The formatting process can sometimes take over 10 seconds to complete. To prevent the risk of damage to data, never attempt to perform any of the following processes before a formatting process has finished:
 - ① Disconnecting the USB-connection AC adapter
 - ② Removing the battery
 - ③ Removing the microSD card (if the recording media has been set to **[microSD card]**)
- Even when formatting or erasing (☞ P.47) is performed, only the file management information of the internal memory and/or microSD card is updated and the recorded data is not completely erased. When disposing of a microSD card, be sure to destroy the card, format the card and record silence until the recording time runs out, or perform a similar operation in order to prevent the leakage of personal information.

Use with a PC

When connecting the voice recorder to a PC you can do the following:

- You can enjoy language content or music files in MP3 and WAV format stored on your PC.
- Use the voice recorder as external storage to save or load data to/from your PC (see P.95).

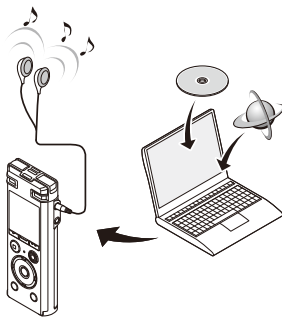

- The earphones are optional

5

PC operating environment

PC operating environment

The requirements shown are the operating environments needed for using a USB connection to save files recorded by the voice recorder on a PC.

Windows

Operating system: Microsoft Windows Vista/7/8, 8.1 standard installation

PC: Windows PC with at least one available USB port

Macintosh

Operating system: Mac OS X 10.5 to 10.10 standard installation

PC: Apple Macintosh series PC with at least one available USB port

NOTE

- Even when the requirements for the operating environment are satisfied, updated versions, multiboot environments, self-modified PCs and other compatible machines will not be covered under the operational warranty.

EN

90

PC connection precautions

- When uploading or downloading a file to or from the voice recorder, data transfer will continue as long as the voice recorder's LED indicator light is flashing, even if the PC data communication screen disappears. Never disconnect the USB connector before data communication has finished. Always use the procedure on [P.94](#) to disconnect the USB connector. Data may not be transferred correctly if you disconnect the connector before the drive has stopped.
- Do not format (initialize) the voice recorder's drive from a PC. Formatting done from a PC will not be done correctly. Use the voice recorder's **[Format]** menu for formatting ([P.88](#)).
- Voice recorder folders or files that are moved or renamed in a Windows or Macintosh file management screen may be reordered or become unrecognizable.
- Note that it will still be possible to read and write data on the voice recorder after setting the attribute of the voice recorder's drive to 'Read only' on a PC.
- To prevent nearby electronic devices being affected by noise, disconnect the external microphone and earphones when connecting the voice recorder to a PC.

PC connection/disconnection

Connecting the voice recorder to a PC

- 1 Start the PC.
- 2 Slide the USB connector slide lever in the direction of the arrow.

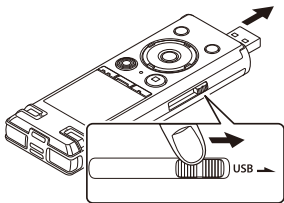

- 3 After making sure the voice recorder is in stop mode, connect its USB connector to a USB port on the PC.

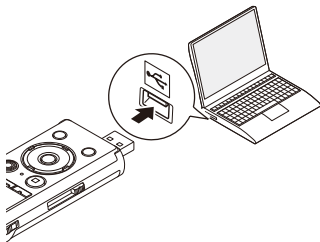

When you use an Olympus nickel-metal hydride rechargeable battery:

- To charge the battery, press the ►OK button.
- To cancel the battery charging, press any button other than ►OK.
- [Remote (Storage)] appears in the voice recorder's display when the USB connector is connected.
- The voice recorder will not connect to the PC if [AC Adapter] was selected for the voice recorder's [USB Connection] setting. Select [PC] for the [USB Connection] setting (P.86).

TIP

- Windows: The voice recorder is recognized and displayed in the [Computer] folder with the model name as the drive name. If there is a microSD card in the voice recorder, it can be used as the [Removable Disk].
- Macintosh: The voice recorder is recognized and displayed on the desktop with the model name as the drive name. If there is a microSD card in the voice recorder, [NO NAME] is displayed.
- For information on the PC's USB port, see the PC's user manual.

NOTE

- Insert the USB connector securely all the way. Operation will not be normal if the connection is not made properly.
- Connecting the voice recorder through a USB hub may result in unstable operation. Do not use a USB hub if operation is unstable.
- Use only a compatible Olympus USB extension cable. Operation is not guaranteed if another manufacturer's cable is used. Only use the Olympus USB extension cable with the voice recorder and never use it with another manufacturer's products.

Disconnecting the voice recorder from a PC

Windows

- 1 Click  on the task bar in the lower right hand corner of the screen and click [Eject DIGITAL VOICE RECORDER].



- The letter used to identify the drive will vary according to your PC.
- When the window indicating it is safe to remove hardware appears, close the window.

- 2 Check that the LED indicator light of the voice recorder has stopped blinking and then disconnect the USB cable.

Macintosh

- 1 Drag-and-drop the removable disk icon for the voice recorder shown on the desktop to the trash can icon.



- 2 Check that the LED indicator light of the voice recorder has stopped blinking and then disconnect the USB cable.

TIP

- You can disconnect the USB cable and use the voice recorder before the battery is fully charged.

NOTE

- To prevent the risk of data damage, never disconnect the voice recorder from the USB port while the LED indicator light is flashing.

Transferring files to a PC

When connecting the voice recorder to a PC you can transfer voice recorder data to save in the PC, and vice-versa. The voice recorder's five folders are displayed on the PC as **[FOLDER_A]**, **[FOLDER_B]**, **[FOLDER_C]**, **[FOLDER_D]** and **[FOLDER_E]** (Fig. C). You can copy voice recorder files to any folder on the PC (Fig. D).

Copying files recorded with the built-in microphone to a PC

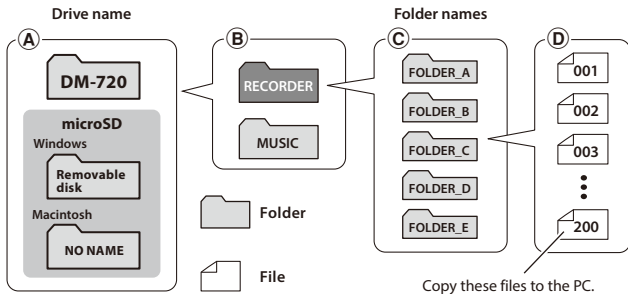

Transferring music files and study content

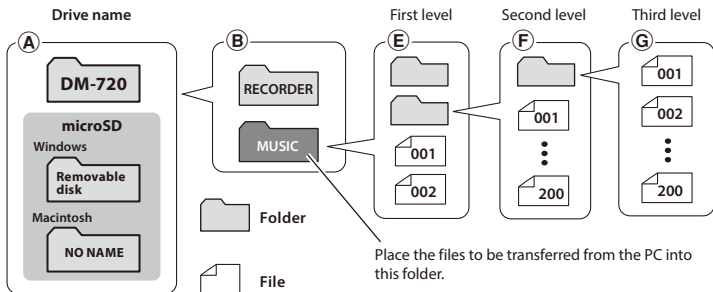

Transferring files to a PC

TIP

- Each folder can store up to 200 files.
- Up to 400 folders can be created within the **[Music]** folder (including a **[Music]** folder itself).
- The voice recorder can only recognize two folder sublevels.

Windows

1 Connect the voice recorder to the PC (☞ P.92).

2 Open Windows Explorer.

- When you open **[Computer]**, the voice recorder is recognized and displayed with the model name as the drive name.

3 Click on the folder labeled with your voice recorder's model name.

4 Copy the desired data to the PC.

5 Disconnect the voice recorder from the PC (☞ P.94).

Macintosh

1 Connect the voice recorder to the PC (☞ P.92).

- When the voice recorder is connected to the Macintosh operating system, it is recognized and displayed on the desktop with the model name as the drive name.

2 Double-click the removable disk icon labeled with your voice recorder's model name.

3 Copy the desired data to the PC.

4 Disconnect the voice recorder from the PC (☞ P.94).

NOTE

- To prevent the risk of data damage, never disconnect the voice recorder from the USB port while the LED indicator light is flashing.

Other information

Alarm message list

Message	Meaning	Action required
Battery low	The remaining battery power is low.	Replace or charge the battery (P.9, P.12).
File locked	An attempt was made to erase a locked file.	You must unlock the file before you can erase it (P.52).
No more can be set	The maximum number of index marks (99) have been written in the file.	Erase unneeded index marks (P.45).
	The maximum number of temp marks (99) have been written in the file.	Erase unneeded temp marks (P.45).
Folder full	The maximum number of files (200) have been saved in the folder.	Erase unneeded files (P.47).
Memory error	An internal memory error occurred.	Contact the Olympus Customer Support Center (P. back cover).
Card error	The microSD card was not recognized correctly.	Remove and reinsert the microSD card (P.17, P.18).
Memory full	There is no remaining memory.	Erase unneeded files (P.47).
No file	There are no files in the folder.	Select another folder (P.22).
Format error	A formatting problem occurred.	Format the memory again (P.88).
Can't create the system file. Connect to PC and erase unnecessary file	The voice recorder is unable to create a management file due to low remaining memory.	Connect the voice recorder to a PC and erase unneeded files.
Cannot play this file	The file's format is not supported.	Select a file that can be played by the voice recorder (P.38).

Alarm message list

Message	Meaning	Action required
Select a file	No file has been selected.	You must select a file before you can perform the operation (☞ P.22).
Same folder can't be moved (copied)	An attempt was made to move (copy) a file to the same folder.	Select another folder.
Some files can't be moved (copied)	A file with the same name as a file being moved (copied) exists in the destination folder.	Select another file.
This file can't be divided.	An attempt was made to divide a file that is not an MP3- or WAV-format file recorded by the voice recorder.	Select another file.
Partial erase unacceptable.	An attempt was made to erase a file that is not a WAV-format file recorded by the voice recorder.	Select another file.

Troubleshooting

Problem	Possible cause	Solution
The display is blank.	The battery is not inserted properly.	Check that the positive and negative terminals of the battery are placed correctly (☞ P.9).
	The remaining battery power is low.	Replace or charge the battery (☞ P.9, P.12).
	The power is OFF.	Turn the power ON (☞ P.10).
Unable to operate the voice recorder	The remaining battery power is low.	Replace or charge the battery (☞ P.9, P.12).
	The power is OFF.	Turn the power ON (☞ P.10).
	The voice recorder is in HOLD mode.	Release HOLD mode (☞ P.19).
Unable to record	There is no remaining memory.	Erase unneeded files (☞ P.47).
	The maximum number of recordable files has been reached.	Select another folder (☞ P.22).
Playback is inaudible.	The earphones are connected to the earphone jack.	To output the playback through the built-in speaker, disconnect the earphones.
	[Off] has been selected for [Speaker].	To output the playback through the built-in speaker, select [On] for [Speaker] (☞ P.66).
	The volume is set to [00].	Adjust the volume (☞ P.34).
The recording is too quiet.	A low recording level has been set.	Redo recording after setting the recording level to [High] or [Middle] (☞ P.54).
	The output level of the connected external device may be too low.	Adjust the output level of the external device.
	The recording level hasn't been adjusted.	Redo recording after adjusting the recording level (☞ P.54).
Audio file sound is distorted.	The recording level hasn't been adjusted.	Redo recording after adjusting the recording level (☞ P.54).
	The voice recorder's recording level, or the output level of the connected external device may be too high.	If the problem continues after adjusting the voice recorder's recording level (☞ P.54), adjust the output level of the external device.

Troubleshooting

6

Troubleshooting

Problem	Possible cause	Solution
An audio file is not recorded in stereo.	The connected external microphone is a mono microphone.	Sound recorded by a connected external mono microphone is recorded on the left channel only.
	[Rec Mode] is set to a mono recording format.	Set [Rec Mode] to a stereo recording format (☞ P.55).
	A positive (+) value has been selected for [Zoom Mic].	Select [Off] for [Zoom Mic] (☞ P.55).
Missing audio file	The file was recorded in a different folder.	Select another folder (☞ P.22).
Noise during playback	Objects brushed against the voice recorder while recording.	Try your best not to touch the voice recorder during recording.
	The voice recorder was placed near a mobile phone or fluorescent light during recording or playback.	Redo the operation with the voice recorder in a different location.
Non-voice portions are not skipped during playback.	The [Voice Detect] process has not been performed.	Use the [Voice Detect] function to extract the speaking portions (☞ P.71).
	[Off] has been selected for [Voice Playback].	Select [On] for [Voice Playback] (☞ P.60).
Unable to erase a file	The file is locked.	You must unlock the file before you can erase it (☞ P.52).
	The file is a read-only file.	Unlock the file, or undo the read-only setting on a PC.
Unable to erase a folder	The folder contains a file that the voice recorder cannot recognize.	Connect the voice recorder to a PC to erase the folder (☞ P.92).
Noise when monitoring a recording	Feedback is being caused.	Connecting a speaker with a built-in amplifier may cause feedback during recording. Using the earphones to monitor recording is recommended.
		Adjust the recording setup such as by moving the earphones and microphone farther apart, or ensuring the microphone is not facing the earphones.

Problem	Possible cause	Solution
Unable to write index marks/temp marks	The maximum number of marks (99) has been reached.	Erase unneeded marks (☞ P.45).
	The file is locked.	Unlock the file (☞ P.52).
	The file is a read-only file.	Unlock the file, or undo the read-only setting on a PC.
Unable to charge the battery	[Alkaline] has been selected for [Battery].	To use the rechargeable battery provided, select [Ni-MH] for [Battery]. Do not use the rechargeable battery at higher/lower temperatures than the recommended range (☞ P.10, P.15, P.67).
	The ►OK button was not pressed.	Press the ►OK button as directed in the confirmation screen shown when connecting the USB connector.
	[Composite] has been selected for [USB Class].	Select [Storage Class] for [USB Class] (☞ P.86).
The PC is unable to recognize the voice recorder.	[AC Adapter] has been selected for [USB Connection].	Select [PC] for [USB Connection] (☞ P.86).
Button operations are abnormal.	[Transcription] or [Language study] has been selected for [Play Scene].	Select [Off] for [Play Scene] (☞ P.39).
Playback speed is fast (or slow).	Playback speed function is set to anything other than [x1.0 Play].	Set the playback speed function setting to [x1.0 Play] (☞ P.41).
Operation is different from usual.	The settings of functions have been changed.	Try [Reset settings]. Various functions will be restored to their initial (factory default) settings. Time clock settings and recorded files are retained (☞ P.69).

Recorder care

- **Exterior**

- Wipe gently with a soft cloth. If the recorder is very dirty, soak the cloth in mild soapy water and wring well. Wipe the recorder with the damp cloth and then wipe it with a dry cloth.

- **Display**

- Wipe gently with a soft cloth.

NOTE

- Do not use benzene, alcohol or other strong solvents, or chemical cleaning cloths.

Accessories (optional)

Accessories for Olympus voice recorders can be purchased directly from the Online Shop on the Olympus website.

Availability of accessories differs depending on the country.

ME15SW stereo microphone

Has a large-diameter built-in microphone for sensitive stereo recording.

ME30W two-channel microphone (omnidirectional)

An omnidirectional microphone pair with a low-noise design ideal for recording in lecture halls or other large venues. The left and right microphones can be placed up to about 5 meters apart.

ME31 compact gun microphone (unidirectional)

A directional gun microphone handy for outdoor recording of wild birds singing and other highly directional applications. The metal body provides a highly rigid body.

ME34 compact zoom microphone (unidirectional)

Comes with an integrated stand ideal for table placement when recording events from a distance, such as conferences or lectures.

ME33 boundary microphone

A microphone for recording conferences that enables connection of up to three left- and three right-channel units. Cascade connection enables the left/right channel connections to be extended up to about 12 meters, to capture sound from a broad range.

ME15 mono tie clip microphone (omnidirectional)

A small, unobtrusive microphone that comes with a tie-clip.

TP8 telephone pickup microphone

An earphone microphone that can be worn in the ear during phone calls. Clearly captures voices and conversations during phone calls.

BR404 nickel-metal hydride AAA rechargeable battery

A high-efficiency, long-lasting rechargeable battery.

A514 USB-connection AC adapter

A USB-connected AC adapter that provides 5-volt DC output. (100-240 VAC, 50/60 Hz)

KA333 connecting cord

A resistive connection cord with stereo mini-plugs (3.5 mm diameter) on both ends. Used to connect the earphone jack output to the line input when recording. Comes with plug adapters (PA331/PA231) that adapt to mono mini plugs (3.5 mm diameter) or mono mini plugs (2.5 mm diameter).

KP19 USB connection cable

CS150 Carrying case

Copyright and trademark information

- The information in this document is subject to change in future without prior notice. Contact Olympus Customer Support Center for the latest product names, model numbers and other information.
- Voice recorder displays and product illustrations shown in this manual may differ from the actual product. While every precaution has been taken to ensure the accuracy of the information in this manual, errors may occasionally arise. Any questions or concerns regarding doubtful information, or possible errors or omissions should be directed to the Olympus Customer Support Center.
- Olympus Corporation is the copyright holders of this manual. Copyright law prohibits unauthorized reproduction of this manual, or unauthorized distribution of reproductions thereof.
- Note that Olympus will assume no liability in the event of damages, lost earnings, or any claims from third parties resulting from improper use of the product.

Trademarks and registered trademarks

- IBM and PC/AT are trademarks or registered trademarks of International Business Machines Corporation.
- Microsoft and Windows are registered trademarks of Microsoft Corporation.
- microSD and microSDHC are trademarks of the SD Card Association.
- Macintosh is a trademark of Apple Inc.
- The product uses MP3 audio coding technology licensed from Fraunhofer IIS and Thomson.
- The product uses voice activity detection technology licensed from NTT Electronics Corporation.

All other brand or product names in this manual are the trademarks or registered trademarks of their respective owners.



Safety precautions

Before using the voice recorder, read this manual to ensure correct and safe operation. After reading this manual, be sure to keep it on hand for ready reference whenever needed.

Important safety precautions

- Important safety precautions in this manual are accompanied by the symbol and labels below. Always follow these precautions to prevent harming yourself or others, or causing damage to property.
- The meaning of each precaution type is given below.



DANGER

A precaution about an imminent danger that is expected to result in death or serious injury if equipment is handled incorrectly.



WARNING

A precaution about a situation that is expected to potentially result in death or serious injury if equipment is handled incorrectly.



CAUTION

A precaution about a situation that is expected to potentially result in injury, or is expected to result only in property damage, if equipment is handled incorrectly.

Voice recorder safety precautions



WARNING

- **Do not use the voice recorder in an atmosphere that might contain flammable or explosive gases.**
It may cause fire or explosion.
- **Do not attempt to disassemble, repair or modify the voice recorder.**
It may cause electric shock or injury.
- **Do not operate the voice recorder while operating a vehicle (such as a bicycle, motorcycle or car).**
It may cause traffic accidents.
- **Do not leave the voice recorder in a location accessible to infants and children.**

Pay attention when using the voice recorder near an infant or child, taking care not to leave it unattended. Infants and children are unable to understand voice recorder safety precautions, and are at risk of accidents such as:

- Strangulation caused by accidental entanglement of the earphone cord around the neck.
- Operation errors resulting in injury or electric shock.

- **If you notice unusual odor, noise, heat, burning odor or smoke coming from the recorder:**
 - ① Disconnect the battery and USB connection immediately, taking care not to burn or injure yourself. Continued use may result in fire or burns (Do not touch the product with bare hands when it's overheating).
 - ② Contact your place of purchase or an Olympus service center.

Safety precautions

- **Do not use the USB power supply via the car cigarette lighter socket or the self-modified power supply.**

It may cause overheating, fire, electric shock or malfunctions.

- **Use microSD/microSDHC memory cards only. Never place other types of cards in the voice recorder.**

If another card type is placed in the voice recorder by accident, do not try to pull it out by force. Contact an Olympus repair center or service center.

- **If the voice recorder is dropped in water or, if water, metal or combustible foreign matter gets inside:**

- ① Remove the battery immediately.
- ② Contact your place of purchase or an Olympus service center for repair. Continued use may result in fire or electric shock.

- **Do not use the voice recorder or use it only as directed in airplanes, hospitals or other locations where use of electronic devices is restricted.**

- **Stop using the voice recorder if you notice unusual odor, noise, or smoke coming from it.**

It may cause fire or burns. Remove the battery immediately, taking care not to burn yourself. Contact your place of purchase or an Olympus repair center or service center. (Do not touch the battery with bare hands when removing it. Remove the battery outdoors, and away from flammable objects.)

- **When carrying the voice recorder by its strap, take care to prevent it becoming caught on other items.**



CAUTION

- **Do not raise the volume before performing an operation.**
Hearing damage or loss may result.

Batteries



DANGER

- **Do not place the battery near ignition sources.**
- **Do not incinerate, heat or disassemble the battery. Do not short-circuit the battery's positive and negative electrodes.**
It may cause fire, ruptures, combustion or overheating.
- **Do not solder connections directly onto the battery. Do not deform, modify or disassemble the battery.**
- **Do not connect the battery's positive and negative terminals.**
It may cause overheating, electric shock or fire.
- **When carrying or storing the battery, always place it in the case and protect its terminals. Do not carry or store the battery together with precious metal items such as key rings.**
It may cause overheating, electric shock or fire.

Safety precautions

- **Do not connect the battery directly to a power outlet or car cigarette lighter.**
- **Do not use or leave the battery in a hot location such as in direct sunlight, inside a vehicle on a hot day, or near a room heater.**

It may cause fire, burns or injuries from leaking, overheating or ruptures.



WARNING

- **Do not touch or hold the battery with wet hands.**
It may cause electric shock or malfunctions.
- **Do not use a battery with a scratched or damaged case.**
It may cause ruptures or overheating.
- **Do not insert the battery with its positive/negative terminals in the opposite direction.**
It may cause leaking, overheating, combustion or ruptures.
 - Do not use a battery with a torn casing seal (insulating covering).
 - Always remove the battery when the voice recorder will not be used for an long period.
 - When disposing used batteries, insulate their contacts with tape and discard them as general waste in the manner prescribed by the local authority.
 - Remove the battery from the voice recorder as soon as the battery becomes unusable. It may cause leakage.

- **Battery fluid in the eyes may cause blindness. If battery fluid gets in eyes, do not rub the eyes. Instead, rinse them thoroughly with tap water or other clean water right away. Go to doctor immediately.**

- **Do not attempt to recharge alkaline, lithium or any other non-rechargeable batteries.**
- **Keep the battery out of the reach of infants and children.**

The battery could be swallowed by infants and children. If swallowed, go to doctor immediately.

- **Do not submerge the battery in freshwater or saltwater, or allow its terminals to become wet.**
- **Discontinue use of the battery if it develops a problem such as leaking, discoloration or deformation.**
- **Stop charging the rechargeable battery if charging has not finished after the specified amount of charging time.**
- **Battery fluid on clothing or skin may damage the skin, so rinse the battery fluid off right away with tap water or other clean water.**



CAUTION

- **Do not throw the battery around, or subject it to strong shocks.**
- **Always charge the rechargeable battery before use when using it for the first time or if it has not been used for a long time.**
- **Rechargeable batteries have a limited life. When the recorders operating time becomes shorter after recharging under the specified condition, please consider that battery is expired and replace it with a new one.**
- **There is a risk of explosion if the battery is replaced with the incorrect battery type.**

When disposing used batteries follow the instructions.

Please recycle batteries to help save our planet's resources. When you throw away dead batteries, be sure to cover their terminals and always observe local laws and regulations.

Disposing the rechargeable battery

- **Recycling batteries helps saving resources. When disposing a used battery, always cover its terminals and observe local laws and regulations.**

Operating precautions

- Do not leave the voice recorder in hot or humid locations such as in direct sunlight inside a vehicle, or on a beach during summer.
- Do not store the voice recorder in humid or dusty locations.
- If the voice recorder becomes wet or damp, wipe off the moisture right away with a dry cloth. Contact with salt water should be particularly avoided.
- Do not place the voice recorder on top of or near a TV, refrigerator or other electrical appliance.
- Prevent sand or mud from getting on the voice recorder. It may cause product not to be repairable.
- Do not subject the voice recorder to intense vibrations or shocks.
- Do not use the voice recorder in humid locations.
- Placing a magnetic card (such as a bank cash card) near the speaker or earphones may cause errors in the data stored on the magnetic card.
- Noise may be heard when the voice recorder is placed near an electric lamp line, fluorescent light or a mobile phone during recording or playback.

<Data loss precautions>

- Recorded content in the internal memory and microSD card may be destroyed or lost due to reasons such as operating errors, device failure or repair.
- Also, when content is saved in the memory for long period of time or is used repeatedly, operations such as writing to, reading from, or erasing of contents may not be possible.
- Making a backup of important recorded information and saving it on a PC's hard disk or other recording media is recommended.
- Note that Olympus will assume no liability for damages or lost earnings resulting from recorded data damage or loss, regardless of the nature or cause thereof.

<Recorded file precautions>

- Note that Olympus will assume no liability for recorded files being erased or becoming unplayable due to voice recorder or PC failure.
- Recording of copyrighted material is permitted when the recording is for your personal use only. Any other type of use without the permission of the copyright owner is prohibited by copyright law.

<Voice recorder and microSD cards disposal precautions>

- Even when formatting (P.88) or erasing (P.47) are performed, only the file management information of the internal memory and/or microSD card is updated and the recorded data is not completely erased.

When disposing of the voice recorder or a microSD card, be sure to destroy it, format and record silence until the recording time runs out, or perform a similar operation in order to prevent the leakage of personal information.

Specifications

General items

■ Recording formats

Linear PCM format

MP3 format

■ Sampling frequency

Linear PCM format

48.0 kHz/16 bits	48.0 kHz
44.1 kHz/16 bits	44.1 kHz

MP3 format

320 kbps	44.1 kHz
128 kbps	44.1 kHz
64 kbps mono	44.1 kHz
8 kbps mono	11.025 kHz

■ Maximum working output

150 mW (8 Ω speaker)

■ Maximum output voltage

Recorder: \leq 150 mV
(according to EN 50332-2)

■ Recording media*

Internal NAND flash memory: 4 GB
microSD card

(Supports card capacities ranging from 2 to 32 GB.)

- * Some recording media memory capacity is used as a management area, so the actual usable capacity will always be slightly less than the displayed capacity.

■ Speaker

Built-in 18 mm diameter round dynamic speaker

■ Microphone jack

3.5 mm diameter; Impedance: 2 k Ω

■ Earphones jack

3.5 mm diameter; Impedance: 8 Ω minimum

■ Power source

Standard voltage: 1.5 V

Battery: One AAA dry cell battery (model LR03), or one Olympus nickel-metal hydride rechargeable battery

External power supply: USB-connection AC adapter (model A514; 5 VDC)

■ External dimensions

105.9 \times 39.6 \times 14.4 mm
(Not including largest projection)

■ Weight

72 g (including battery)

■ Operating temperature

0 to 42°C (32 to 107.6°F)

Frequency response

■ When recording from microphone jack

Linear PCM format

48.0 kHz/16 bits	20 Hz to 23 kHz
44.1 kHz/16 bits	20 Hz to 21 kHz

MP3 format

320 kbps	20 Hz to 21 kHz
128 kbps	20 Hz to 17 kHz
64 kbps mono	20 Hz to 13 kHz
8 kbps mono	20 Hz to 3.5 kHz

■ When recording with built-in stereo microphone

20 Hz to 20 kHz ([**Central Mic On**])

60 Hz to 20 kHz ([**Central Mic Off**])

(Frequency response upper limit is set by recording mode during MP3-format recording.)

■ During playback

20 Hz to 20 kHz

(The upper and lower limit values of the frequency response depend on each recording format.)

Specifications

Battery life

The figures below are guideline values.

■ When recording with built-in stereo microphone (using internal memory)

Recording mode		Alkaline dry cell battery	Nickel-metal hydride rechargeable battery
Linear PCM format	48.0 kHz/16 bits	26 hours (approx.)	20 hours (approx.)
	44.1 kHz/16 bits	28 hours (approx.)	21 hours (approx.)
MP3 format	320 kbps	31 hours (approx.)	22 hours (approx.)
	128 kbps	35 hours (approx.)	25 hours (approx.)
	64 kbps mono	39 hours (approx.)	28 hours (approx.)
	8 kbps mono	52 hours (approx.)	38 hours (approx.)

■ During audio file playback (all playback modes)

During speaker playback

Recording mode		Alkaline dry cell battery	Nickel-metal hydride rechargeable battery
Linear PCM format	48.0 kHz/16 bits	13 hours (approx.)	11 hours (approx.)
	44.1 kHz/16 bits	13 hours (approx.)	11 hours (approx.)
MP3 format	320 kbps	13 hours (approx.)	11 hours (approx.)
	128 kbps	13 hours (approx.)	11 hours (approx.)
	64 kbps mono	13 hours (approx.)	11 hours (approx.)
	8 kbps mono	13 hours (approx.)	11 hours (approx.)

During earphone playback

Recording mode		Alkaline dry cell battery	Nickel-metal hydride rechargeable battery
Linear PCM format	48.0 kHz/16 bits	26 hours (approx.)	20 hours (approx.)
	44.1 kHz/16 bits	28 hours (approx.)	21 hours (approx.)
MP3 format	320 kbps	30 hours (approx.)	22 hours (approx.)
	128 kbps	30 hours (approx.)	22 hours (approx.)
	64 kbps mono	31 hours (approx.)	22 hours (approx.)
	8 kbps mono	35 hours (approx.)	25 hours (approx.)

Specifications

NOTE

- The battery life figures shown here were determined using an Olympus test method (When [**Mic Select**] is set to [**Central Mic Off**], and [**LED**] is set to [**Off**]). Actual battery life figures will vary greatly according to the battery used and usage conditions (Changing the playback speed or using the [**Zoom Mic**], [**Noise Cancel**] and [**Voice Balancer**] functions may affect the battery life).
- Battery life will be shorter when using a nickel-metal hydride rechargeable battery that has been used repeatedly.
- Battery life will be shorter when using a microSD card.

Recording time

The figures below are guideline values.

■ Linear PCM format

Recording media		Recording mode	
		48.0 kHz/16 bits	44.1 kHz/16 bits
Internal memory	4 GB	5 hours (approx.)	5 hours, 30 minutes (approx.)
	32 GB	44 hours (approx.)	48 hours (approx.)
microSD card	16 GB	22 hours (approx.)	23 hours, 30 minutes (approx.)
	8 GB	11 hours (approx.)	11 hours, 30 minutes (approx.)

■ MP3 format

Recording media		Recording mode			
		320 kbps	128 kbps	64 kbps mono	8 kbps mono
Internal memory	4 GB	24 hours, 30 minutes (approx.)	61 hours (approx.)	123 hours (approx.)	985 hours (approx.)
	32 GB	212 hours (approx.)	530 hours (approx.)	1060 hours (approx.)	8480 hours (approx.)
microSD card	16 GB	105 hours (approx.)	264 hours (approx.)	525 hours (approx.)	4220 hours (approx.)
	8 GB	52 hours (approx.)	132 hours (approx.)	264 hours (approx.)	2110 hours (approx.)

Specifications

NOTE

- Actually available recording times may be shorter than the figures shown here when making short recordings repeatedly (Equipment displays of available/elapsed recording times should be considered guideline values).
- Available recording time will also vary due to differences in the available memory capacity of different microSD cards.

Maximum recording time per file

- The maximum file size is limited to about 4 GB in the MP3 format, and to about 2 GB in the linear PCM (WAV) format.
- Regardless of the amount of remaining memory, the maximum recording time per file is restricted to the following values:

■ Linear PCM format

Recording mode	Recording time
48.0 kHz/16 bits	3 hours (approx.)
44.1 kHz/16 bits	3 hours, 20 minutes (approx.)

■ MP3 format

Recording mode	Recording time
320 kbps	29 hours, 40 minutes (approx.)
128 kbps	74 hours, 30 minutes (approx.)
64 kbps mono	149 hours (approx.)
8 kbps mono	1193 hours (approx.)

Number of music tracks (songs) that can be recorded

The figures below are guideline values.

Internal memory (4 GB)	900 tracks (approx.)
------------------------	----------------------

(At 128 kbps, 4 minutes per track)

Note that voice recorder specifications and appearance are subject to change without prior notice for performance improvements or other upgrading.

For customers in North and South America:

FCC Notice

- This equipment has been tested and found to comply with the limits for a Class B digital device, pursuant to Part 15 of the FCC Rules. These limits are designed to provide reasonable protection against harmful interference in a residential installation.
- This equipment generates, uses, and can radiate radio frequency energy and, if not installed and used in accordance with the instructions, may cause harmful interference to radio communications.
- However, there is no guarantee that interference will not occur in a particular installation. If this equipment does cause harmful interference to radio or television reception, which can be determined by turning the equipment off and on, the user is encouraged to try to correct the interference by one or more of the following measures:
 - Reorient or relocate the receiving antenna.
 - Increase the separation between the equipment and receiver.
 - Connect the equipment into an outlet on a circuit different from that to which the receiver is connected.
 - Consult the dealer or an experienced radio/TV technician for help.
 - Use only Olympus' supplied cable or AC adapter when you connect the applicable equipment to an external device or a power outlet.

FCC CAUTION

Changes or modifications not expressly approved by the party responsible for compliance could void the user's authority to operate the equipment.

For customers in USA

Declaration of Conformity

Model Number: DM-720

Trade Name: OLYMPUS

Responsible Party: OLYMPUS AMERICA INC.

Address: 3500 Corporate Parkway, P.O. Box 610, Center Valley, PA 18034-0610, U.S.A.

Telephone Number: 484-896-5000

Tested To Comply With FCC Standards FOR HOME OR OFFICE USE

This device complies with Part 15 of the FCC rules. Operation is subject to the following two conditions:

- (1) This device may not cause harmful interference, and
- (2) this device must accept any interference received, including interference that may cause undesired operation.

For customers in CANADA

CAN ICES-3 (B)/NMB-3 (B)

OLYMPUS®

OLYMPUS CORPORATION

2951 Ishikawa-machi, Hachioji-shi, Tokyo 192-8507, Japan.

OLYMPUS AMERICA INC.

3500 Corporate Parkway, P.O. Box 610, Center Valley, PA 18034-0610, U.S.A.
Tel. 484-896-5000

Technical Support (USA):

24/7 online automated help:

[http://www.olympusamerica.com/
support](http://www.olympusamerica.com/support)

Phone customer support:

Tel.: 1-888-553-4448 (Toll-free)

Our phone customer support is available from 9 am to 9 pm (Monday to Friday) ET

[http://www.olympusamerica.com/
contactus](http://www.olympusamerica.com/contactus)

Olympus software updates can be obtained at:

<http://www.olympusamerica.com/digital>

OLYMPUS IMAGING AUSTRALIA PTY LTD.

Ground Floor, 82 Waterloo Road, Macquarie Park NSW 2113, Australia PO Box 1991 Macquarie Centre NSW 2113

Tel: +61 2 9886 3992

<http://www.olympus.com.au>

Customer Service Centres:

Australia

Olympus Imaging Australia Pty Ltd.

Tel: **1300 659 678**

Fax: **+61 2 9889 7988**

<http://www.olympus.com.au>

New Zealand

Dictation Distributors Ltd.

Tel: **0800 659 678**

Fax: **+64 9 303 3189**

<http://www.dictation.co.nz>

OLYMPUS IMAGING SINGAPORE PTE. LTD.

491B River Valley Road #12-01/04 Valley Point Office Tower, Singapore 248373

Tel. (65) 6834-0010

<http://www.olympus.com.sg>

OLYMPUS (MALAYSIA) SDN. BHD.

Unit No.10-8, Menara 1MK, Kompleks '1 Mont' Kiara', No.1, Jalan Kiara, Mont' Kiara,

50480 Kuala Lumpur, Malaysia

Tel. (60) 3-6411-0000

<http://www.olympus.com.my>

OLYMPUS HONG KONG AND CHINA LIMITED

L43, Office Tower, Langham Place, 8 Argyle Street, Mongkok, Kowloon, Hong Kong

Tel. (852) 2481-7812

<https://www.olympus.com.hk>

OLYMPUS (THAILAND) CO., LTD.

Imaging Products Division

23/112 Sorachai Building, 27th Floor, Soi Sukhumvit 63 (Ekamai), Sukhumvit Road,

Klongton Nua, Wattana, Bangkok, 10110 Thailand

Tel. (66) 2-787-8200

<http://www.olympusimaging-th.com>